

NEW!
Ranges and finish options



Price List & Technical Guide November 2009



BE INSPIRED...



Welcome!!

Welcome to Cardale's price list and technical guide containing an inspirational range of high quality doors - the largest range of styles in the UK!



Cardale is British owned and has been manufacturing Garage Doors for over forty years. We're sure you'll find the right door for your home amongst Cardale's stylish range - no one offers more choice!

Where to buy??

Cardale doors are available through a network of independent garage doors specialists who will be able to provide full details and prices for our range.



Visit www.cardale.com or call : **0800 581082** for details of your nearest distributor. Amongst the distributors are those achieving Gold standard - visit www.golddistributor.co.uk or www.cardale.com for your nearest Gold Distributor.

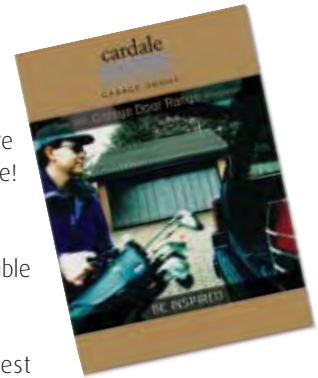

See our "At a glance" guide for more information on the Cardale range

"Be Inspired..."



P4 STEEL UP & OVER DOORS



P8 TIMBER UP & OVER DOORS HERITAGE RANGE



P10 TIMBER UP & OVER DOORS FUTURA RANGE



P12 ABS UP & OVER DOORS ELITE RANGE



P14 GRP UP & OVER DOORS



P18 STEEL, GRP, TIMBER & ABS SIDE HINGED & PERSONNEL DOORS



P22 ROLLER DOORS THERMAGLIDE & STEEL-LINE RANGES



P25 SECTIONAL DOORS GRP RANGE



P26 SECTIONAL DOORS THERMALIFT 42 RANGE



P28 REMOTE CONTROL DOOR OPERATORS



P29 FRAMES, WINDOWS & ACCESSORIES

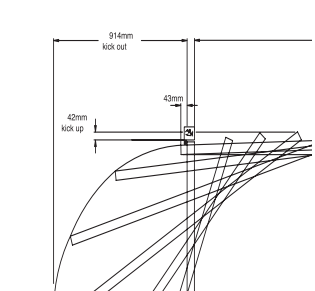

P30 NOTES & TECHNICAL INFORMATION

...Add security and value to your home with Cardale"

PRICES

All orders are accepted on the understanding that the goods will be subject to the prices ruling at the time of delivery, unless other terms are specifically agreed. All prices are in £ sterling and exclude carriage and VAT.

Cardale reserves the right to alter specifications to design and manufacture without notification. All specifications are correct at time of publication, errors and omissions excepted. Colours shown in this brochure are limited by the print reproduction process and should be used as a guide only.

How to use this price list!

Pricing your door can look complicated - mainly due to the huge number of sizes and styles we have! Don't worry, it is straightforward - see below for your guide!

Technical details and other information on the range of products can be found in the last section of this guide - if you are unsure about pricing your door contact your local specialist - see the "Where to buy" section on the facing page.

My Door



Canopy

Standard Single Doors width x height

1981 x 1981	6'6" x 6'6"	
1981 x 2134	6'6" x 7'0"	
2083 x 1905	6'10" x 6'3"	
2108 x 1981	6'10" x 6'6"	
2108 x 2134	6'10" x 7'0"	
2134 x 1905	7'0" x 6'3"	
2134 x 1930	7'0" x 6'4"	
2134 x 1956	7'0" x 6'5"	
2134 x 1981	7'0" x 6'6"	433
2134 x 2134	7'0" x 7'0"	
2222 x 1930	7'3.5" x 6'4"	
2222 x 1981	7'3.5" x 6'6"	
2222 x 2134	7'3.5" x 7'0"	
2261 x 1981	7'5" x 6'6"	
2261 x 2134	7'5" x 7'0"	

For Maximizer Retractable gear add £40 to the prices above

Standard Double Doors width x height

		Retractable Gear
2743 x 1981/2134	9'0" x 6'6"/7'0"	815
4267 x 1981/2134	14'0" x 6'6"/7'0"	1259
4420 x 1981/2134	14'6" x 6'6"/7'0"	1594
4572 x 1981/2134	15'0" x 6'6"/7'0"	1646
4877 x 1981/2134	16'0" x 6'6"/7'0"	1697

Options - add the supplement as listed

	Single	double
Finishes		
Plastisol - Weatherwhite	65	110
Weathergrain - Golden Oak, Rosewood	125	220
Glazing	Single/double	
Stippled Plain, Square Lattice, Diamond Lattice	-	-
Feature	-	-
Frames *54mm canopy doors only	Single	double
Prima *54 or 68mm	95	170
Painted *54 or 68mm white, black, brown	95	170
Brass Effect Handle	42	
Flush Lock	42	

Made To Measure Sizes

Take the next standard size up from the table above and add: **£100**
Refer to the tables below to confirm size availability

	Minimum width mm	Maximum width mm	Minimum height mm	Maximum height mm
For heights over 2134mm up to 2286mm, add the supplement to 2134mm height price.	1778	1778	1778	1829*
	2438	4877	1778	1829*
	1778	1829*	2134	2286
	2134	2286		

= £678

How to price your door

- 1 Locate the style and door size you require from the tables of standard sizes to find your base price. If a size or option isn't priced (-) it is not available for that style of door. Sizes may be precise or in size bands depending on door type. OR If you require a made to measure door locate the appropriate width/height band to find your base price. For up and over, side hinged and personnel doors use the size availability table to check your required width/height is possible.
- 2 Select your options - finish, windows, etc and add the supplement to the base price from above. **A '0' denotes a no cost option.**
- 3 Select your frame and add the supplement to the base price from above.
- 4 If you have selected a made to measure door check your size is within the ranges shown. You may be required to add a supplement to a standard size price or select from an appropriate price band for the size required.
- 5 You now have your price. For full details of the specification of your door consult the technical information in the last section of this guide.



PAINTED STEEL UP & OVER GARAGE DOORS

NEW!

check list for all doors - use the list below to confirm the details of your door

Canopy gear is available on doors up to 2438mm (8'0") wide and 2134mm (7'0") high. See individual styles for size range.

Sizes listed are the ordering sizes. These are internal frame sizes, doors are built to allow clearance within these dimensions - see page 30 onwards for details.

For an intermediate size your style must be available with made to measure as an option.

- Doors are supplied prepared with a lock hole unless specified otherwise.
- Frames are supplied to match the door finish unless specified otherwise.
- Framed canopy doors are supplied with a 54mm frame unless specified otherwise.
- N.B.** Check the information for your chosen style to ensure the sizes and options required are available.

Aries II



Gemini II



Georgian



Chevron



Olympian II



Brompton II



Finishes:

Finish options are Prima - Primed ready for painting to a colour of your choice or one of the deep textured paint colours shown below

PRIMA WHITE



DEEP TEXTURED PAINT



Photographs show 2134mm x 2134mm doors, illustrations show the configuration of a 4267mm x 2134mm double door. Feature size and spacing may vary for Intermediate sizes - If in doubt please refer to Cardale before ordering.

Options - add the supplement as listed

Finishes

	Single Doors	double Doors
Fully finished white	59	90
Fully finished colours	85	133

Glazing

	Single Doors	double Doors
Stippled Plain Olympian II	220	410

Frames

	Single Doors	double Doors
Primed, Powder coat Painted white, or matching frame 68mm	95	170
Primed, Powder coat Painted white, or matching frame 54mm (canopy only)	95	-

Four Point latching kit

	Single Doors	double Doors
Upgrades door from two to four latches	26	41

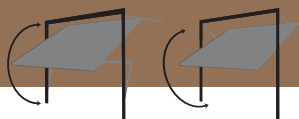

Canopy & Retractable gear

PAINTED STEEL UP & OVER GARAGE DOORS

Prices shown for white prima finish

For retractable gear on single doors add £40 to the prices below

Standard Single Doors

width x height		Aries II Canopy	Gemini II Canopy	Brompton II Canopy	Olympian II Canopy	Georgian Canopy	Chevron Canopy
1930 x 2134	6'4" x 7'0"	432	491	626	626	626	-
1981 x 1981	6'6" x 6'6"	432	491	626	626	626	-
1981 x 2134	6'6" x 7'0"	438	492	639	639	639	-
2083 x 1905	6'10" x 6'3"*	445	504	606	606	-	-
2083 x 1930	6'10" x 6'4"	448	498	606	606	606	-
2083 x 1956	6'10" x 6'5"	454	513	606	606	606	-
2083 x 1981	6'10" x 6'6"	461	513	606	606	606	-
2083 x 2057	6'10" x 6'9"	477	522	638	638	638	-
2083 x 2134	6'10" x 7'0"	477	522	638	638	638	-
2108 x 1981	6'11" x 6'6"	461	519	636	636	636	-
2108 x 2057	6'11" x 6'9"	477	524	667	667	667	-
2108 x 2134	6'11" x 7'0"	477	524	667	667	667	-
2134 x 1829	7'0" x 6'0"*	461	516	606	-	-	-
2134 x 1880	7'0" x 6'2"*	461	516	606	-	-	-
2134 x 1905	7'0" x 6'3"*	461	516	606	606	-	-
2134 x 1930	7'0" x 6'4"	453	506	606	606	606	-
2134 x 1956	7'0" x 6'5"	466	510	638	638	638	-
2134 x 1981	7'0" x 6'6"	419	489	604	604	604	489
2134 x 2057	7'0" x 6'9"	455	503	638	638	638	-
2134 x 2134	7'0" x 7'0"	455	503	638	638	638	503
2210 x 1930	7'3" x 6'4"	477	540	677	677	677	-
2210 x 1981	7'3" x 6'6"	482	530	682	682	682	-
2210 x 2134	7'3" x 7'0"	486	535	684	684	684	-
2261 x 1981	7'5" x 6'6"	491	551	700	700	700	-
2261 x 2134	7'5" x 7'0"	553	608	827	827	827	-
2286 x 1829	7'6" x 6'0"*	480	535	677	-	-	-
2286 x 1880	7'6" x 6'2"*	480	535	677	-	-	-
2286 x 1905	7'6" x 6'3"*	480	535	677	677	-	-
2286 x 1930	7'6" x 6'4"	480	535	677	677	677	-
2286 x 1981	7'6" x 6'6"	479	534	682	682	682	534
2286 x 2134	7'6" x 7'0"	548	586	797	797	797	586
2438 x 1905	8'0" x 6'3"*	529	611	827	827	827	-
2438 x 1930	8'0" x 6'4"	553	629	816	816	816	-
2438 x 1981	8'0" x 6'6"	553	629	816	816	816	-
2438 x 2134	8'0" x 7'0"	564	656	871	871	871	-

*sizes available with canopy gear only

Standard Double Doors

all available in either 1981mm or 2134mm heights (6'6" / 7'0") at the same price

widths	Retractable	Retractable	Retractable	Retractable	Retractable	Retractable
2591 8'6"	856	930	1109	1109	1109	-
2743 9'0"	856	930	1109	1109	1109	-
3048 10'0"	1076	1018	1339	1339	1339	-
3353 11'0"	1205	1307	1446	1446	1446	-
3658 12'0"	1319	1378	1577	1577	1577	-
3962 13'0"	1403	1469	1753	1753	1753	-
4242 13'11"	1522	1540	1919	1919	1919	-
4267 14'0"	1322	1340	1719	1719	1719	1340
4420 14'6"	1674	1654	1958	1958	1958	-
4572 15'0"	-	1693	2081	2081	2081	-
4877 16'0"	-	1879	2204	2204	2204	-

Made to Measure Doors

all available up to 2286mm high (7'6") at the same price (check table below for size availability)

widths	Canopy	Retract	Canopy	Retract	Canopy	Retract	Canopy	Retract	Canopy	Retract	Canopy	Retract
1981 6'6"	538	578	592	632	739	779	739	779	739	779	-	-
2134 7'0"	555	595	603	643	738	778	738	778	738	778	-	-
2286 7'6"	648	688	686	726	897	937	897	937	897	937	-	-
2438 8'0"	664	704	756	796	971	1011	971	1011	971	1011	-	-
2591 8'6"	-	1056	-	1130	-	1309	-	1309	-	1309	-	-
2743 9'0"	-	1056	-	1130	-	1309	-	1309	-	1309	-	-
3048 10'0"	-	1276	-	1218	-	1539	-	1539	-	1539	-	-
3353 11'0"	-	1405	-	1507	-	1646	-	1646	-	1646	-	-
3658 12'0"	-	1519	-	1578	-	1777	-	1777	-	1777	-	-
3962 13'0"	-	1603	-	1669	-	1953	-	1953	-	1953	-	-
4267 14'0"	-	1522	-	1540	-	1919	-	1919	-	1919	-	-
4572 15'0"	-	-	-	1893	-	2281	-	2281	-	2281	-	-
4877 16'0"	-	-	-	2079	-	2404	-	2404	-	2404	-	-

Made to measure size availability

	Canopy	Retract	Canopy	Retract	Canopy	Retract	Canopy	Retract	Canopy	Retract	Canopy	Retract
Minimum width mm	1829	1829	1829	1829	1829	1829	1829	1829	1829	1829	-	-
Maximum width mm	2438	4267	2438	4877	2438	4877	2438	4877	2438	4877	-	-
Minimum height mm	1829	1918	1829	1918	1918	1918	1905	1918	1931	1931	-	-
Maximum height mm	2134	2286	2134	2286	2134	2286	2134	2286	2134	2134	-	-



WHITE PLASTISOL & WEATHERGRAIN STEEL UP & OVER GARAGE DOORS

check list for all doors - use the list below to confirm the details of your door

Canopy gear is available on doors up to 2438mm (8'0") wide and 2134mm (7'0") high. See individual styles for size range.

Sizes listed are the ordering sizes. These are internal frame sizes, doors are built to allow clearance within these dimensions - see page 30 onwards for details.

For an intermediate size your style must be available with made to measure as an option.

- Doors are supplied prepared with a lock hole unless specified otherwise.
- Frame colour must be specified with your order.
- Framed canopy doors are supplied with a 54mm frame unless specified otherwise.
- N.B.** Check the information for your chosen style to ensure the sizes and options required are available.

Aries II



Europa



Gemini II

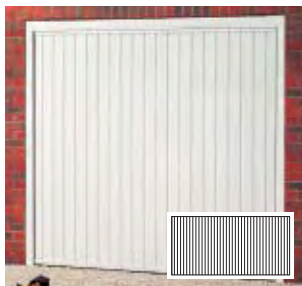

Georgian



Jacobean



Sheraton



Bedford

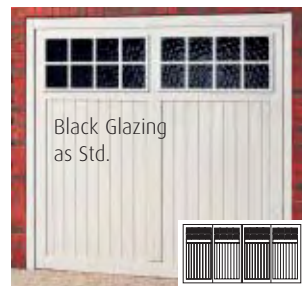

Berkeley



Gatcombe



Ibstock



Finishes:

Finish options are Plastisol - a high performance leathergrain finish or Weathergrain high performance woodgrain laminate.

PLASTISOL

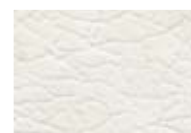

Weatherwhite

WEATHERGRAIN



Golden Oak



Rosewood

Photographs show 2134mm x 2134mm doors, Illustrations show the configuration of a 4267mm x 2134mm double door. Feature size and spacing may vary for Intermediate sizes - If in doubt please refer to Cardale before ordering.

Options - add the supplement as listed

	Single Doors	double Doors
Finishes		
Weathergrain - Golden Oak and Rosewood	60	110
Glazing		
Stippled Plain Bedford - stippled plain only	100	195
Stippled Plain, Square Lattice, Diamond Lattice Sheraton. No-cost option on the Ibstock.	220	410
Frames		
Powder coat Painted white, black or brown 68mm	95	170
Powder coat Painted white, black or brown 54mm (canopy only)	95	-
Four Point latching kit		
Upgrades door from two to four latches	26	41

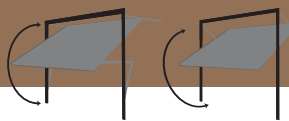

Canopy & Retractable gear

WHITE PLASTISOL & WEATHERGRAIN
STEEL UP & OVER GARAGE DOORS

Prices shown for Weatherwhite Plastisol finish
For retractable gear on single doors
add £40 to the prices below

Standard Single Doors		Aries II Canopy	Europa Canopy	Gemini II Canopy	Georgian Canopy	Sheraton Jacobean Canopy	Berkeley Gatcombe Ibstock Canopy	Bedford Canopy
width x height								
1930 x 2134	6'4" x 7'0"	497	497	556	691	-	-	-
1981 x 1981	6'6" x 6'6"	497	497	556	691	-	-	-
1981 x 2134	6'6" x 7'0"	503	503	557	704	-	-	-
2083 x 1905	6'10" x 6'3"	510	510	569	-	-	-	-
2083 x 1930	6'10" x 6'4"	513	513	563	671	-	-	-
2083 x 1956	6'10" x 6'5"	519	519	578	671	-	-	-
2083 x 1981	6'10" x 6'6"	526	526	578	671	-	-	-
2083 x 2057	6'10" x 6'9"	542	542	587	703	-	-	-
2083 x 2134	6'10" x 7'0"	542	542	587	703	-	-	-
2108 x 1981	6'11" x 6'6"	526	526	584	701	-	-	-
2108 x 2057	6'11" x 6'9"	542	542	589	732	-	-	-
2108 x 2134	6'11" x 7'0"	542	542	589	732	-	-	-
2134 x 1829	7'0" x 6'0"*	526	526	581	-	-	-	-
2134 x 1880	7'0" x 6'2"*	526	526	581	-	-	-	-
2134 x 1905	7'0" x 6'3"*	526	526	581	-	-	-	-
2134 x 1930	7'0" x 6'4"	518	518	571	671	-	-	-
2134 x 1956	7'0" x 6'5"	531	531	575	703	-	-	-
2134 x 1981	7'0" x 6'6"	484	484	554	669	669	897	897
2134 x 2057	7'0" x 6'9"	520	520	568	703	-	-	-
2134 x 2134	7'0" x 7'0"	520	520	568	703	703	902	902
2210 x 1930	7'3" x 6'4"	542	542	605	742	-	-	-
2210 x 1981	7'3" x 6'6"	547	547	595	747	-	-	-
2210 x 2134	7'3" x 7'0"	551	551	600	749	-	-	-
2261 x 1981	7'5" x 6'6"	556	556	616	765	-	-	-
2261 x 2134	7'5" x 7'0"	618	618	673	892	-	-	-
2286 x 1829	7'6" x 6'0"*	545	545	600	-	-	-	-
2286 x 1880	7'6" x 6'2"*	545	545	600	-	-	-	-
2286 x 1905	7'6" x 6'3"*	545	545	600	-	-	-	-
2286 x 1930	7'6" x 6'4"	545	545	600	742	-	-	-
2286 x 1981	7'6" x 6'6"	544	544	599	747	747	928	928
2286 x 2134	7'6" x 7'0"	613	613	651	862	862	931	931
2438 x 1905	8'0" x 6'3"*	594	594	676	892	-	-	-
2438 x 1930	8'0" x 6'4"	618	618	694	881	-	-	-
2438 x 1981	8'0" x 6'6"	618	618	694	881	881	980	980
2438 x 2134	8'0" x 7'0"	629	629	721	936	936	981	981

*sizes available with canopy gear only

Standard Double Doors all available in either 1981mm or 2134mm heights (6'6" / 7'0") at the same price

widths	Retractable	Retractable	Retractable	Retractable	Retractable	Retractable	Retractable
2591 8'6"	966	-	1040	1219	-	-	-
2743 9'0"	966	-	1040	1219	-	-	-
3048 10'0"	1186	-	1128	1449	-	-	-
3353 11'0"	1315	-	1417	1556	-	-	-
3658 12'0"	1429	-	1488	1687	-	-	-
3962 13'0"	1513	-	1579	1863	-	-	-
4242 13'11"	1632	-	1650	2029	-	-	-
4267 14'0"	1432	-	1450	1829	1829	-	2068
4420 14'6"	1784	-	1764	2068	-	-	-
4572 15'0"	-	-	1803	2191	-	-	-
4877 16'0"	-	-	1989	2314	-	-	-

Made to Measure Doors all available up to 2286mm high (7'6") at the same price (Check table below for size availability)

widths	Canopy Retract		Canopy Retract		Canopy Retract		Canopy Retract		Canopy Retract		Canopy Retract		Canopy Retract	
1981 6'6"	603	643	603	643	657	697	804	844	-	-	-	-	-	-
2134 7'0"	620	660	620	660	668	708	803	843	-	-	-	-	-	-
2286 7'6"	713	753	713	753	751	791	962	1002	962	1002	-	-	-	-
2438 8'0"	729	769	729	769	821	861	1036	1076	1036	1076	-	-	-	-
2591 8'6"	-	1166	-	-	-	1240	-	1419	-	-	-	-	-	-
2743 9'0"	-	1166	-	-	-	1240	-	1419	-	-	-	-	-	-
3048 10'0"	-	1386	-	-	-	1328	-	1649	-	-	-	-	-	-
3353 11'0"	-	1515	-	-	-	1617	-	1756	-	-	-	-	-	-
3658 12'0"	-	1629	-	-	-	1688	-	1887	-	-	-	-	-	-
3962 13'0"	-	1713	-	-	-	1779	-	2063	-	-	-	-	-	-
4267 14'0"	-	1632	-	-	-	1650	-	2029	-	-	-	-	-	-
4572 15'0"	-	-	-	-	-	2003	-	2391	-	-	-	-	-	-
4877 16'0"	-	-	-	-	-	2189	-	2514	-	-	-	-	-	-

Made to measure size availability

	Canopy	Retract	Canopy	Retract	Canopy	Retract	Canopy	Retract	Canopy	Retract	Canopy	Retract	Canopy	Retract
Minimum width mm	1829	1829	1829	1829	1829	1829	1930	1930	2185	2185	-	-	-	-
Maximum width mm	2438	4267	2438	2438	2438	4877	2438	4877	2438	2438	-	-	-	-
Minimum height mm	1829	1918*	1829	1918*	1829	1918*	1930	1930*	1981**	1981**	-	-	-	-
Maximum height mm	2134	2286	2134	2286	2134	2286	2134	2134	2134*	2134*	-	-	-	-

*1854 (6'1") on doors over 2438 (8'0") wide

**1981 (6'6") & 2134 (7'0") heights only on Jacobean & Sheraton

HERITAGE TIMBER UP & OVER GARAGE DOORS

check list for all doors - use the list below to confirm the details of your door

Canopy gear is available on doors up to 2438mm (8'0") wide and 2134mm (7'0") high. See individual styles for size range.

Sizes listed are the ordering sizes. These are internal frame sizes, doors are built to allow clearance within these dimensions - see page 30 onwards for details.

For an intermediate size your style must be available with made to measure as an option.



Doors are supplied prepared with a lock hole unless specified otherwise.



Framed canopy doors are supplied with a 54mm frame unless specified otherwise.



N.B. Check the information for your chosen style to ensure the sizes and options required are available.



HERITAGE TIMBER UP & OVER GARAGE DOORS

Bronte



Cardinal



Chiltern



Countryman



Dulwich



Hampstead



Hathaway



Midhurst



Stuart



Thornley



Trafalgar



Trafford



Tudor



Windsor



York



Key:

The symbols denote sizing and window availability. Photographs show 2134mm x 2134mm doors, Illustrations show the configuration of a 4267mm x 2134mm double door. Feature size and spacing may vary for Intermediate sizes - If in doubt please refer to Cardale before ordering.

Finishes:

Futura and Heritage Timber up & over doors are supplied base coat stained for finishing to the colour of your choice. The doors are also available fully finished as an optional extra in four woodtones as shown.

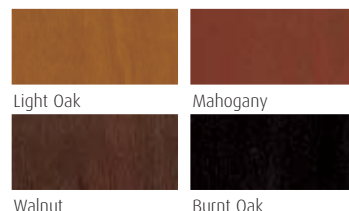

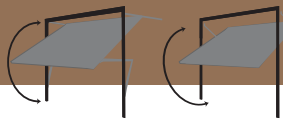

Canopy & Retractable gear **TIMBER UP & OVER GARAGE DOORS**

Prices shown for basecoat finish with canopy gear on single doors, retractable gear on double doors

Cardinal
Chiltern
Countryman
Thornley
Trafalgar
Tudor
Windsor

Bronte

Standard Single Doors		Dulwich	Stuart	Cardinal Chiltern Countryman Thornley Trafalgar Tudor Windsor	York	Bronte Trafford	Hampstead	Hathaway	Midhurst*
width x height		Canopy	Canopy	Canopy	Canopy	Canopy	Canopy	Canopy	Retractable
2134 x 1981	7'0" x 6'6"	850	850	996	996	1321	1566	1566	1608
2134 x 2134	7'0" x 7'0"	850	850	998	998	1370	1613	1613	1655
2286 x 1981	7'6" x 6'6"	919	919	1011	1011	1511	1779	1779	1821
2286 x 2134	7'6" x 7'0"	941	941	1013	1013	1564	1833	1833	1875
2438 x 1981	8'0" x 6'6"	926	926	1024	1024	1665	1951	1951	1993
2438 x 2134	8'0" x 7'0"	928	928	1026	1026	1713	2005	2005	2047

For Maximizer Retractable gear add to the prices above:

£40

*Midhurst is only available on Retractable gear and is priced including the £40 supplement

Standard Double Doors

width x height		Retractable	Retractable	Retractable	Retractable	Retractable	Retractable	Retractable	Retractable
4267 x 1981	14'0" x 6'6"	1801	1801	2433	2433	2948	3492	3492	-
4267 x 2134	14'0" x 7'0"	1801	1801	2435	2435	2948	3492	3492	-

Made To Measure Single Doors - sizes up to:

width x height		Canopy	Canopy	Canopy	Canopy	Canopy	Canopy	Canopy	Retractable
2134 x 2134	7'0" x 7'0"	-	930	995	-	1349	-	1688	-
2438 x 2134	8'0" x 7'0"	-	1160	1250	-	1662	-	2082	-

For Maximizer Retractable gear add to the prices above:

£40

For doors over 2134mm (7'0") high up to 2438 (8'0") add to the prices above:

£100

*Single door sizes in this range are only available with maximizer gear - the £100 must be added to the maximizer retractable door price.

Made To Measure Double Doors - sizes up to:

width x height		Retractable	Retractable	Retractable	Retractable	Retractable	Retractable	Retractable	Retractable
2743 x 2134	9'0" x 7'0"	-	1403	1730	-	1952	-	2383	-
3048 x 2134	10'0" x 7'0"	-	1594	1770	-	2189	-	2635	-
3353 x 2134	11'0" x 7'0"	-	1788	2284	-	2424	-	2887	-
3658 x 2134	12'0" x 7'0"	-	1838	2309	-	2661	-	3138	-
3962 x 2134	13'0" x 7'0"	-	2174	2509	-	2897	-	3389	-
4267 x 2134	14'0" x 7'0"	-	2289	2661	-	3134	-	3639	-
4572 x 2134	15'0" x 7'0"	-	2818	3094	-	3369	-	3891	-
4877 x 2134	16'0" x 7'0"	-	3029	3312	-	3606	-	4146	-

For doors over 2134mm (7'0") high up to 2438 (8'0") add to the prices above:

£200

Options - add the supplement as listed

	Single	double
Fully Finished		
Light Oak, Mahogany, Walnut & Burnt Oak	118	195
Glazing		
Stippled Plain (Standard), Square Lattice, Diamond Lattice <small>Hampstead Stippled Plain only.</small>	0	0
Frames		
Powder coat Painted white, black or brown 68mm	95	170
Powder coat Painted white, black or brown 54mm (canopy only)	95	-
Prima *54 / 68mm	95/110	190
Plastisol *54 / 68mm white, black, brown	110/125	205
Weathergrain *54 / 68mm Golden Oak, Rosewood	120/135	215
Brass Effect Handle		42

} available from feb 1st

} available until feb 1st

Made To Measure Sizes Refer to the table below to confirm size availability

	Canopy	Retract	Canopy	Retract	Canopy	Retract	Canopy	Retract	Canopy	Retract	Canopy	Retract
Minimum width mm	-	-	1778	1778	1778	1778	-	-	1778	1778	-	-
Maximum width mm	-	-	2438	4877	2438	4877	-	-	2438	4877	-	-
Minimum height mm	-	-	1778	*1829	1778	*1829	-	-	1778	*1829	-	-
Maximum height mm	-	-	2134	2438	2134	2438	-	-	2134	2438	-	-

1778 = 5'10" 1829 = 6'0" 2134 = 7'0" 2438 = 8'0" 4267 = 14'0" 4877 = 16'0"

*1854 (6'1") on double doors

FUTURA TIMBER UP & OVER GARAGE DOORS

check list for all doors - use the list below to confirm the details of your door

Canopy gear is available on doors up to 2438mm (8'0") wide and 2134mm (7'0") high. See individual styles for size range.

Sizes listed are the ordering sizes. These are internal frame sizes, doors are built to allow clearance within these dimensions - see page 30 onwards for details.

For an intermediate size your style must be available with made to measure as an option.



Doors are supplied prepared with a lock hole unless specified otherwise.



Framed canopy doors are supplied with a 54mm frame unless specified otherwise.



N.B. Check the information for your chosen style to ensure the sizes and options required are available.



FUTURA TIMBER UP & OVER GARAGE DOORS

Bedford



Bedford Chevron



Berkeley Chevron

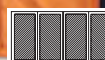

Berkeley Vertical



Burley



Chevron



Cotswold



Gatcombe



Horizontal



Doors feature a dark brown edging section

Strathmore



Ibstock



Theydon



Sandringham



Vertical

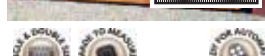

Doors feature a dark brown edging section

Stamford



Wisley



Key:

The symbols denote sizing and window availability. Photographs show 2134mm x 2134mm doors, Illustrations show the configuration of a 4267mm x 2134mm double door. Feature size and spacing may vary for Intermediate sizes - If in doubt please refer to Cardale before ordering.

Finishes:

Futura and Heritage Timber up & over doors are supplied base coat stained for finishing to the colour of your choice. The doors are also available fully finished as an optional extra in four woodtones as shown.

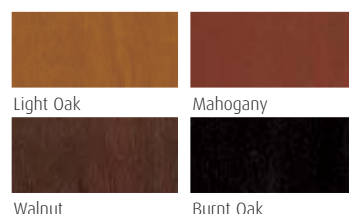

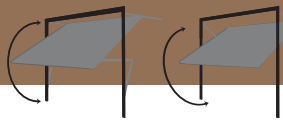

Canopy & Retractable gear **TIMBER UP & OVER GARAGE DOORS**

Prices shown for basecoat finish with canopy gear on single doors, retractable gear on double doors

Burley
Chevron
Cotswold
Bedford
Bedford
Chevron
Ibstock
Strathmore
Stamford
Theydon

Standard Single Doors

width x height	Horizontal	Vertical	*Berkeley Chevron *Berkeley Vertical	Burley Chevron Cotswold Sandringham	Wisley	Bedford Bedford Chevron	Ibstock Stamford	Strathmore Theydon
	Canopy	Canopy	Canopy	Canopy	Canopy	Canopy	Canopy	Canopy
2134 x 1981 7'0" x 6'6"	1153	1153	1412	1412	1412	1609	1760	1760
2134 x 2134 7'0" x 7'0"	1153	1153	1415	1415	1415	1623	1800	1800
2286 x 1981 7'6" x 6'6"	1189	1189	1501	1501	1501	1779	1946	1946
2286 x 2134 7'6" x 7'0"	1228	1228	1506	1506	1506	1837	2013	2013
2438 x 1981 8'0" x 6'6"	1269	1269	1546	1546	1546	1903	2088	2088
2438 x 2134 8'0" x 7'0"	1294	1294	1548	1548	1548	1945	2157	2157

For Maximizer Retractable gear add to the prices above:

£40

*Single Berkeley Chevron /Vertical doors are supplied with twin handles to mimic side hinged look

Standard Double Doors

width x height	Retractable	Retractable	Retractable	Retractable	Retractable	Retractable	Retractable	Retractable
4267 x 1981 14'0" x 6'6"	-	2546	3029	3029	3029	3625	3878	3878
4267 x 2134 14'0" x 7'0"	-	2546	3029	3029	3029	3625	3878	3878

Made To Measure Single Doors - sizes up to:

width x height	Canopy	Canopy	Canopy	Canopy	Canopy	Canopy	Canopy	Canopy
1981 x 2134 6'6" x 7'0"	1203	1203	1425	1425	-	1648	1800	-
2134 x 2134 7'0" x 7'0"	1224	1224	1467	1467	-	1648	1877	-
2286 x 2134 7'6" x 7'0"	1273	1273	1556	1556	-	1841	2056	-
2438 x 2134 8'0" x 7'0"	1328	1328	1572	1572	-	1960	2235	-

For Maximizer Retractable gear add to the prices above:

£40

For doors over 2134mm (7'0") high up to 2438 (8'0") add to the prices above:

£100

*Single door sizes in this range are only available with maximizer gear - the £100 must be added to the maximizer retractable door price.

Made To Measure Double Doors - sizes up to:

width x height	Retractable	Retractable	Retractable	Retractable	Retractable	Retractable	Retractable	Retractable
2743 x 2134 9'0" x 7'0"	1942	1942	2208	2208	-	2253	2576	-
3048 x 2134 10'0" x 7'0"	1963	1963	2396	2396	-	2312	2871	-
3353 x 2134 11'0" x 7'0"	-	2327	2718	2718	-	2908	3163	-
3658 x 2134 12'0" x 7'0"	-	2558	2854	2854	-	3145	3455	-
3962 x 2134 13'0" x 7'0"	-	2790	3031	3031	-	3748	3748	-
4267 x 2134 14'0" x 7'0"	-	2641	3102	3102	-	3721	3942	-
4572 x 2134 15'0" x 7'0"	-	3226	3400	3400	-	4069	4328	-
4877 x 2134 16'0" x 7'0"	-	3460	3616	3616	-	4429	4618	-

For doors over 2134mm (7'0") high up to 2438 (8'0") add to the prices above:

£200

Options - add the supplement as listed

	Single	double
Fully Finished		
Light Oak, Mahogany, Walnut & Burnt Oak	118	195
Glazing		
Stippled Plain (Standard), Square Lattice, Diamond Lattice Bedford, Bedford Chevron, Strathmore & Theydon Stippled Plain Only	0	0
Frames		
Powder coat Painted white, black or brown 68mm	95	170
Powder coat Painted white, black or brown 54mm (canopy only)	95	-
Prima *54 / 68mm	95/110	190
Plastisol *54 / 68mm white, black, brown	110/125	205
Weathergrain *54 / 68mm Golden Oak, Rosewood	120/135	215
Brass Effect Handle		42

Made To Measure Sizes Refer to the table below to confirm size availability

	Canopy	Retract	Canopy	Retract	Canopy	Retract	Canopy	Retract	Canopy	Retract	Canopy	Retract
Minimum width mm	1778	1778	1778	1778	1778	1778	-	-	1778	1778	1778	1778
Maximum width mm	2438	3048	2438	4877	2438	4877	2438	4877*	2438	4877	2438	4877
Minimum height mm	1778	*1829	1778	*1829	1778	*1829	1778	*1829	1778	*1829	1778	*1829
Maximum height mm	2134	2438	2134	2438	2134	2438	2134	2438	2134	2438	2134	2438

1778 = 5'10" 1829 = 6'0" 2134 = 7'0" 2438 = 8'0" 4267 = 14'0" 4877 = 16'0"

*1854 (6'1") on double doors * Chevron 4267 (14'0")

ABS UP & OVER GARAGE DOORS

check list for all doors - use the list below to confirm the details of your door

Canopy gear is available on doors up to 2438mm (8'0") wide and 2134mm (7'0") high. See individual styles for size range.

Sizes listed are the ordering sizes. These are internal frame sizes, doors are built to allow clearance within these dimensions - see page 30 onwards for details.

For an intermediate size your style must be available with made to measure as an option.

Doors are supplied prepared with a lock hole unless specified otherwise.

Frames are supplied in white unless specified otherwise.

Framed canopy doors are supplied with a 54mm frame unless specified otherwise.

N.B. Check the information for your chosen style to ensure the sizes and options required are available.

ABS ELITE UP & OVER GARAGE DOORS

Bedford Black glazing as std



Jacobean



President



Regal



Senator



Tudor



Bedford

	Minimum	Maximum	Minimum	Maximum
Width	6' 8"	8' 4"	-	-
	2032	2540	-	-
Height	6' 1 1/2"	7' 3 1/2"	-	-
	1873	2216	-	-



Jacobean

	Minimum	Maximum	Minimum	Maximum
Width	6' 6 1/8"	8' 3 1/8"	-	-
	1991	2524	-	-
Height	6' 2 1/2"	7' 3 1/2"	-	-
	1895	2223	-	-



President

	Minimum	Maximum	Minimum	Maximum
Width	6' 5 1/8"	8' 4"	12' 11 3/4"	14' 9 1/2"
	1959	2540	3956	4515
Height	6' 4"	7' 3 1/4"	6' 4"	7' 3 1/4"
	1930	2229	1930	2229



Regal

	3 Panel		4 Panel	
	Minimum	Maximum	Minimum	Maximum
Width	6' 3 1/2"	8' 4 1/2"	8' 5"	9' 1 1/8"
	1911	2559	2565	2791
Height	6' 3 1/2"	7' 4"	6' 3 1/2"	7' 4"
	1918	2235	1918	2235
	5 Panel		6 Panel	
	Minimum	Maximum	Minimum	Maximum
Width	10' 6 1/8"	11' 3 1/4"	12' 8 1/8"	14' 9"
	3223	3448	3883	4515
Height	6' 3 1/2"	7' 4"	6' 3 1/2"	7' 4"
	1918	2235	1918	2235



Senator

	4 Panel		5 Panel	
	Minimum	Maximum	Minimum	Maximum
Width	6' 7 1/8"	8' 4 1/2"	8' 3 1/8"	8' 8 1/8"
	2016	2552	2524	2645
Height	6' 0"	7' 4"	6' 0"	7' 4"
	1829	2235	1829	2235
	6 Panel		7 Panel	
	Minimum	Maximum	Minimum	Maximum
Width	9' 11 3/8"	10' 4 1/4"	11' 7 1/8"	12' 0 1/4"
	3032	3156	3540	3664
Height	6' 0"	7' 4"	6' 0"	7' 4"
	1829	2235	1829	2235
	8 Panel			
	Minimum	Maximum		
Width	13' 3 3/8"	14' 9 1/4"		
	4048	4515		
Height	6' 0"	7' 4"		
	1829	2235		



Tudor

	Minimum	Maximum	Minimum	Maximum
Width	6' 6 1/8"	8' 3 1/8"	-	-
	1991	2530	-	-
Height	6' 3"	7' 3"	-	-
	1905	2210	-	-

Key:

The symbols denote sizing and window availability. Photographs show 2134mm x 2134mm doors, illustrations show the configuration of a 4267mm x 2134mm double door. Feature size and spacing may vary for Intermediate sizes - If in doubt please refer to Cardale before ordering.



Finishes:

ABS doors have an impact resistant white low gloss finish which closely match to white PVCu doors and windows.

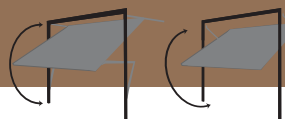

Canopy & Retractable gear

ABS UP & OVER GARAGE DOORS

Prices shown with canopy gear
on single doors, retractable
gear on double doors

		Jacobean	Tudor	Regal	Senator	Bedford	President
Standard Single Doors							
width x height		Canopy	Canopy	Canopy	Canopy	Canopy	Canopy
2134 x 1981	7'0" x 6'6"	845	845	804	845	928	928
2134 x 2134	7'0" x 7'0"	845	845	804	845	928	928
2286 x 1981	7'6" x 6'6"	928	928	889	928	1013	1013
2286 x 2134	7'6" x 7'0"	928	928	889	928	1013	1013
2438 x 1981	8'0" x 6'6"	1013	1013	974	1013	1096	1096
2438 x 2134	8'0" x 7'0"	1013	1013	974	1013	1096	1096

For Maximizer Retractable gear add to the prices above:

£40

Standard Double Doors

		Retractable	Retractable	Retractable	Retractable	Retractable	Retractable
width x height							
4267 x 1981	14'0" x 6'6"	1966	-	1883	1966	-	2090
4267 x 2134	14'0" x 7'0"	1966	-	1883	1966	-	2090

Made To Measure Single Doors - sizes up to:

		Canopy	Canopy	Canopy	Canopy	Canopy	Canopy
width x height							
2134 x 2134	7'0" x 7'0"	971	971	928	971	1052	1052
2286 x 2134	7'6" x 7'0"	1052	1052	1013	1052	1136	1136
2438 x 2134	8'0" x 7'0"	1136	1136	1096	1136	1221	1221

For Maximizer Retractable gear add to the prices above:

£40

For doors over 2134mm (7'0") high up to 2261 (7'5") add to the prices above*:

£60

*Single door sizes in this range are only available with maximizer gear - the £60 must be added to the maximizer retractable door price.
Refer to the table on the left hand page to confirm availability.

Made To Measure Double Doors - sizes up to:

		Retractable	Retractable	Retractable	Retractable	Retractable	Retractable
width x height							
2591 x 2134	8'6" x 7'0"	1292	1292	1250	1292	1439	1439
2743 x 2134	9'0" x 7'0"	-	-	1250	1292	-	-
3048 x 2134	10'0" x 7'0"	-	-	1412	1460	-	-
3353 x 2134	11'0" x 7'0"	-	-	1569	1649	-	-
3658 x 2134	12'0" x 7'0"	-	-	1661	1809	-	2090
3962 x 2134	13'0" x 7'0"	-	-	1729	-	-	2238
4267 x 2134	14'0" x 7'0"	-	-	2039	2095	-	2285
4572 x 2134	15'0" x 7'0"	-	-	2357	2437	-	2469

For doors over 2134mm (7'0") high up to 2261 (7'5") add to the prices above:

£100

Refer to the table on the left hand page to confirm availability.

Options - add the supplement as listed

	Single	double
Glazing		
Stippled Plain / Square Lattice / Diamond Lattice / Queen Anne Lattice Regal & Senator only.	220	410
Stippled Plain Bedford Stippled Plain only.	100	195
Frames		
Powder coat Painted white, black or brown 68mm	95	170
Powder coat Painted white, black or brown 54mm (canopy only)	95	-
Prima *54 / 68mm	95/110	190
Plastisol *54 / 68mm white, black, brown	110/125	205
Weathergrain *54 / 68mm Golden Oak, Rosewood	120/135	215
Brass Effect Handle		42

} available from Jan 4th

} available until Jan 4th

GLASSWHITE GRP UP & OVER GARAGE DOORS

check list for all doors - use the list below to confirm the details of your door

Canopy gear is available on doors up to 2438mm (8'0") wide and 2134mm (7'0") high. See individual styles for size range.

Sizes listed are the ordering sizes. These are internal frame sizes, doors are built to allow clearance within these dimensions - see page 30 onwards for details.

For an intermediate size your style must be available with made to measure as an option.



Doors are supplied prepared with a lock hole unless specified otherwise.



Framed canopy doors are supplied with a 54mm frame unless specified otherwise.



N.B. Check the information for your chosen style to ensure the sizes and options required are available.



GLASSWHITE GRP UP & OVER GARAGE DOORS

Arcadian



Belgravia



Carolina



Elgin



Georgian



Gloucester



Herald



Sunburst



Westminster

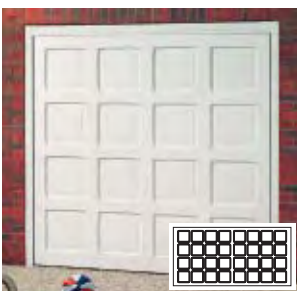

Key:

The symbols denote sizing and window availability. Photographs show 2134mm x 2134mm doors, illustrations show the configuration of a 4267mm x 2134mm double door. Feature size and spacing may vary for Intermediate sizes - If in doubt please refer to Cardale before ordering.

Finishes:

Hand finished high gloss white.



Premium - Rear view
The PREMIUM range has steel reinforcing laminated into the rear of the door for added strength and rigidity.



Deluxe - Rear view The DELUXE range features a double skin flat back construction with internal steel reinforcing. Doors over 10' wide feature external white powder coated steel horizontal stiffeners to the rear of the panel for increased rigidity. **Deluxe build doors are only available with black mock glazing.**

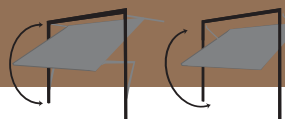

Canopy & Retractable gear

GRP UP & OVER GARAGE DOORS

Prices shown with canopy gear on single doors, retractable gear on double doors. Premium Build

Standard Single Doors

width x height		Arcadian	Belgravia	Carolina	Elgin	Georgian	Gloucester	Herald	Sunburst	Westminster
		Canopy	Canopy	Canopy	Canopy	Canopy	Canopy	Canopy	Canopy	Canopy
2134 x 1981	7'0" x 6'6"	1340	1057	1340	1078	1026	1078	1057	1089	1196
2134 x 2134	7'0" x 7'0"									
2286 x 1981	7'6" x 6'6"	1451	1276	1451	1109	1086	1109	1276	1226	1359
2286 x 2134	7'6" x 7'0"									
2438 x 1981	8'0" x 6'6"	1550	1319	1550	1152	1130	1152	1319	1359	1362
2438 x 2134	8'0" x 7'0"									

For Maximizer Retractable gear add to the prices above:

£40

Standard Double Doors

width x height		Retract	Retract	Retract	Retract	Retract	Retract	Retract	Retract	Retract
2591 x 1981	8'6" x 6'6"	-	-	-	-	1509	-	-	-	-
2591 x 2134	8'6" x 7'0"									
2743 x 1981	9'0" x 6'6"	-	-	-	-	1509	-	-	-	-
2743 x 2134	9'0" x 7'0"									
2896 x 1981	9'6" x 6'6"	-	-	-	-	1509	-	-	-	-
2896 x 2134	9'6" x 7'0"									
3048 x 1981	10'0" x 6'6"	-	-	-	-	1651	-	-	-	-
3048 x 2134	10'0" x 7'0"									
3353 x 1981	11'0" x 6'6"	-	-	-	-	1845	-	-	-	-
3353 x 2134	11'0" x 7'0"									
3658 x 1981	12'0" x 6'6"	-	-	-	-	1988	-	-	-	-
3658 x 2134	12'0" x 7'0"									
3962 x 1981	13'0" x 6'6"	-	-	-	-	2025	-	-	-	-
3962 x 2134	13'0" x 7'0"									
4267 x 1981	14'0" x 6'6"	2622	-	-	-	1982	-	-	2252	2263
4267 x 2134	14'0" x 7'0"									
4420 x 1981	14'6" x 6'6"	-	-	-	-	2348	-	-	2749	2732
4420 x 2134	14'6" x 7'0"									
4572 x 2286	15'0" x 7'6"	-	-	-	-	-	-	-	-	-
4877 x 2286	16'0" x 7'6"	-	-	-	-	-	-	-	-	-

Options - add the supplement as listed

	Single	double
Deluxe Build		
(Black mock glazing only)	248	322
Glazing		
Black (Standard)/Smoked Arcadian, Carolina & Sunburst	0	0
Black (Standard)/Smoked Belgravia, Georgian & Westminster	125	250
Clear / Stippled Carolina & Sunburst	280	560
Clear / Stippled Arcadian, Georgian & Westminster	255	510
Square/Diamond Lattice Belgravia, Georgian & Westminster only*	0	0
Frames		
Powder coat Painted white, black or brown 68mm	95	170
Powder coat Painted white, black or brown 54mm (canopy only)	95	-
Prima *54 / 68mm	95/110	190
Plastisol *54 / 68mm white, black, brown	110/125	205
Weathergrain *54 / 68mm Golden Oak, Rosewood	120/135	215
Brass Effect Handle		42

*Doors that do not feature glazing as part of the standard design require a window option supplement to be added to qualify for the lattice option.

Made To Measure Sizes Take the next standard size up from the table above°

°Single door sizes over 2134mm (7'0") high are only available with maximizer gear

Refer to the table below to confirm size availability

	C	R	C	R	C	R	C	R	C	R	C	R	C	R	C	R		
Minimum width mm	2057	2057	-	-	2082	2082	2134	2134	2134	2134	2134	2134	-	-	2057	2057	2057	2057
Maximum width mm	2438	4267	-	-	2438	2438	2438	2438	2438	4420	2438	2438	-	-	2438	4420	2438	4420
Minimum height mm	1981	1981	-	-	1943	1943	1981	1981	1930	1930	1981	1981	-	-	1981	1981	1981	1981
Maximum height mm	2134	2134	-	-	2134	2134	2134	2134	2134	2134	2134	2134	-	-	2134	2134	2134	2134

1930 = 6'4" 1943 = 6'4.5" 1981 = 6'6" 2057 = 6'9" 2134 = 7'0" 2438 = 8'0" 4267 = 14'0" 4420 = 14'6" 4877 = 16'0"

GLASSWOOD GRP UP & OVER GARAGE DOORS

check list for all doors - use the list below to confirm the details of your door

Canopy gear is available on doors up to 2438mm (8'0") wide and 2134mm (7'0") high. See individual styles for size range.

Sizes listed are the ordering sizes. These are internal frame sizes, doors are built to allow clearance within these dimensions - see page 30 onwards for details.

For an intermediate size your style must be available with made to measure as an option.



Doors are supplied prepared with a lock hole unless specified otherwise.



Framed canopy doors are supplied with a 54mm frame unless specified otherwise.



N.B. Check the information for your chosen style to ensure the sizes and options required are available.



GLASSWOOD GRP UP & OVER GARAGE DOORS

Aspen



Collingtree



Gwent



Hambleton



Lyndhurst



Mansfield



Nelson



Sulgrave



Sutherland



Key:

The symbols denote sizing and window availability. Photographs show 2134mm x 2134mm doors, illustrations show the configuration of a 4267mm x 2134mm double door. Feature size and spacing may vary for Intermediate sizes - If in doubt please refer to Cardale before ordering.

Finishes:

Highly detailed, low maintenance timbergrain effect GRP doors available in twelve woodtone finishes.

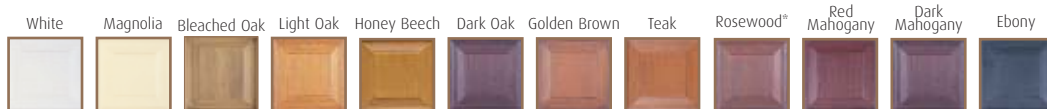

*Although sharing the same name, Rosewood Glasswood GRP doors and Rosewood Weathergrain steel frames are not a match for colour. Dark Mahogany is the closest in colour - always ask to see a sample if you are unsure.



Premium - Rear view

The PREMIUM range has steel reinforcing laminated into the rear of the door for added strength and rigidity.



Deluxe - Rear view

The DELUXE range features a double skin flat back construction with internal steel reinforcing. Doors over 10' wide feature external white powder coated steel horizontal stiffeners to the rear of the panel for increased rigidity. **Deluxe build doors are only available with black mock glazing.**

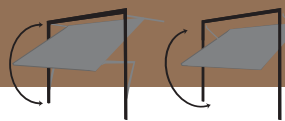

Canopy & Retractable gear

GRP UP & OVER GARAGE DOORS

Prices shown with canopy gear on single doors, retractable gear on double doors. Premium Build

Standard Single Doors

width x height	Aspen Widegrain Canopy	Collingtree Narrowgrain Canopy	Gwent Narrowgrain Canopy	Hambledon Widegrain Canopy	Lyndhurst Widegrain Canopy	Mansfield Narrowgrain Canopy	Nelson Narrowgrain Canopy	Sulgrave Narrowgrain Canopy	Sutherland Narrowgrain Canopy
2134 x 1981	1161	1161	1161	1192	1174	1161	1161	1370	1370
2134 x 2134									
2286 x 1981	1337	1337	1337	1370	1350	1337	1337	1411	1411
2286 x 2134									
2438 x 1981	1381	1381	1381	1414	1395	1381	1381	1454	1454
2438 x 2134									

For Maximizer Retractable gear add to the prices above:

£40

Standard Double Doors

width x height	Retract	Retract	Retract	Retract	Retract	Retract	Retract	Retract	Retract
2591 x 1981	-	-	1636	1696	1748	-	-	-	-
2591 x 2134									
2743 x 1981	-	-	1636	-	1752	1558	-	-	-
2743 x 2134									
2896 x 1981	-	-	1779	-	1899	-	-	-	-
2896 x 2134									
3048 x 1981	-	-	1779	-	1902	-	-	-	-
3048 x 2134									
3353 x 1981	-	-	1951	-	2085	-	-	-	-
3353 x 2134									
3658 x 1981	-	-	2180	-	2323	2076	-	-	-
3658 x 2134									
3962 x 1981	-	2256	2256	-	2402	-	-	-	-
3962 x 2134									
4267 x 1981	2233	2278	2278	2480	2445	2233	2278	2307	2307
4267 x 2134									
4420 x 1981	2608	2608	2608	2977	2936	2608	2608	2590	2590
4420 x 2134									
4572 x 2286	-	-	2608	-	-	-	-	-	-
4877 x 2286	-	-	2867	-	-	-	-	-	-

Options - add the supplement as listed

	Single	double
Deluxe Build (Black mock glazing only)	248	322
Glazing		
Black (Standard) /Smoked Sulgrave & Sutherland	0	0
Black (Standard) /Smoked Lyndhurst & Mansfield	125	250
Clear/Stippled Sulgrave	280	560
Clear/Stippled Lyndhurst & Mansfield	255	510
Clear/Stippled Sutherland	335	670
Square/Diamond Lattice Lyndhurst & Mansfield only*	0	0
Frames		
Powder coat Painted white, black or brown 68mm	95	170
Powder coat Painted white, black or brown 54mm (canopy only)	95	-
Prima *54 / 68mm	95/110	190
Plastisol *54 / 68mm white, black, brown	110/125	205
Weathergrain *54 / 68mm Golden Oak, Rosewood	120/135	215
Brass Effect Handle		42

} available from feb 1st

} available until feb 1st

*Doors that do not feature glazing as part of the standard design require a window option supplement to be added to qualify for the lattice option.

Made To Measure Sizes Take the next standard size up from the table above°

°Single door sizes over 2134mm (7'0") high are only available with maximizer gear

Refer to the table below to confirm size availability

	C	R	C	R	C	R	C	R	C	R	C	R	C	R	C	R	C	R		
Minimum width mm	2134	2134	2057	2057	2108	2108	2134	2134	2134	2134	2083	2083	1981	1981	2057	2057	2083	2083	2134	2134
Maximum width mm	2438	4267	2438	4267	2438	4648	2438	4877	2438	4877	2438	4420	2438	4572	2438	4420	2438	4572	2438	4572
Minimum height mm	1829	1829	1981	1981	1905	1905	1981	1981	1930	1930	1981	1981	1981	1981	1981	1981	1880	1880	1930	1930
Maximum height mm	2134	2134	2134	2134	2134	2134	2134	2286	2134	2134	2134	2134	2134	2134	2134	2134	2134	2134	2134	2134

1930 = 6'4" 1943 = 6'4.5" 1981 = 6'6" 2057 = 6'9" 2134 = 7'0" 2438 = 8'0" 4267 = 14'0" 4420 = 14'6" 4877 = 16'0"

Aspen widths 2032 - 2438 & 4204 - 4648 heights 1829 - 1981 & 2007 - 2134 for widths up to 2438 wide and 1930 - 2134 for widths from 4204 - 4648 wide Collingtree widths 2108 - 2438 & 3743 - 4648

Mansfield widths 1981 - 2845, 3429 - 3962 & 4078 - 4572 Sutherland widths 2134 & 2184 - 2591 & 4242 - 4877 Sulgrave widths 2083 - 2540 & 4115 - 4877

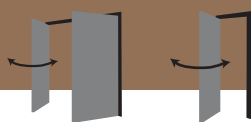

STEEL SIDE HINGED GARAGE DOORS & PERSONNEL DOORS

STEEL SIDE HINGED GARAGE DOORS & PERSONNEL DOORS

Prices shown for Prima Finish & Frame

Gemini

Georgian

Personnel Standard Doors

width x height		Personnel	Personnel
762 x 2134	2'6" x 7'0"	436	443
914 x 2134	3'0" x 7'0"	534	542
1219 x 2134	4'0" x 7'0"	602	662

Personnel Made to Measure Take next standard size up and add £50 (for 2286mm (7'6") high use 2134mm (7'0") high price. Use table at foot of page to confirm size availability.

Side Hinged Standard Doors

width x height		Side Hinged	Side Hinged
1981 x 1981	6'6" x 6'6"	882	-
1981 x 2134	6'6" x 7'0"	891	-
2134 x 1981	7'0" x 6'6"	863	964
2134 x 2134	7'0" x 7'0"	912	994
2286 x 1981	7'6" x 6'6"	934	1041
2286 x 2134	7'6" x 7'0"	985	1117
2438 x 1981	8'0" x 6'6"	998	1146
2438 x 2134	8'0" x 7'0"	1011	1172

Side Hinged Made To Measure Doors Take the next size up from the table Refer to the table at the foot of the page to confirm size availability

width x height		Side Hinged	Side Hinged
1981 x 1981	6'6" x 6'6"	982	-
1981 x 2134	6'6" x 7'0"	991	-
1981 x 2286	6'6" x 7'6"	991	-
2134 x 1981	7'0" x 6'6"	963	1064
2134 x 2134	7'0" x 7'0"	1012	1094
2134 x 2286	7'0" x 7'6"	1012	1094
2286 x 1981	7'6" x 6'6"	1034	1141
2286 x 2134	7'6" x 7'0"	1085	1217
2286 x 2286	7'6" x 7'6"	1085	1217
2438 x 1981	8'0" x 6'6"	1098	1246
2438 x 2134	8'0" x 7'0"	1111	1272
2438 x 2286	8'0" x 7'6"	1111	1272

Options - add the supplement as listed

	Personnel	Side Hinged
Finishes		
Painted white	40	70
Painted colours	65	95
Plastisol - Weatherwhite	65	95
Weathergrain - Golden Oak, Rosewood	125	180
Frames		
Un-Framed deduct	20	40
65mm painted white, black, brown	20	20
Security & Draft Fur Pack	125	125
Left Hand Opening	0	55

Key:

The symbols denote sizing and window availability. Photographs show 2134mm x 2134mm doors. Feature size and spacing may vary for Intermediate sizes - If in doubt please refer to Cardale before ordering.

Finishes:

Finish options are Prima - Primed ready for painting to a colour of your choice or one of the deep textured paint colours shown below, WhitePlastisol - a high performance leathergrain finish or Weathergrain high performance woodgrain laminate.

	Personnel	Personnel
Minimum width mm	419 1'4.5"	756 2'5.75"
Maximum width mm	1219 4'0"	1067 3'6"
Minimum height mm	1829 6'0"	1829 6'0"
Maximum height mm	2286 7'6"	2134 7'0"

	Side Hinged	Side Hinged
Minimum width mm	1219 4'0"	2134 7'0"
Maximum width mm	2438 8'0"	2438 8'0"
Minimum height mm	1829 6'0"	1930 6'4"
Maximum height mm	2286 7'6"	2134 7'0"

check list for all doors - use the list below to confirm the details of your door

Sizes listed are the ordering sizes. These are internal frame sizes, doors are built to allow clearance within these dimensions - see page 30 onwards for details.

All doors are complete with a 65mm frame

Doors are supplied with a lock hole unless specified otherwise.

Doors are outward opening only and with the lock on the right hand leaf when viewed from outside.

N.B. Check the information for your chosen style to ensure the sizes and options required are available.

Gemini



Georgian



PRIMA



White Prima

DEEP TEXTURED PAINT



See full range of colours on page 6

PLASTISOL



Weatherwhite

WEATHERGRAIN



Golden Oak



Rosewood

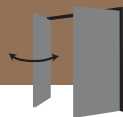

CLASSIC SIDE HINGED GARAGE DOORS

CLASSIC TIMBER SIDE HINGED GARAGE DOORS

Chevron



Garage Lite



Gatcombe



Malvern



Milton



Rutland



Shakespeare



Vertical



Finishes:

Classic doors are supplied base coat stained for finishing to the colour of your choice. The doors are also available fully finished as an optional extra in four woodtones as shown.



Prices shown for basecoat Finish & Prima Frame Side Hinged Standard Doors

width x height		Rutland Shakespeare	Gatcombe Malvern	Milton Vertical	Chevron Garage Lite
		Side Hinged	Side Hinged	Side Hinged	Side Hinged
1981 x 1981	6'6" x 6'6"	1453	1749	1749	1925
1981 x 2134	6'6" x 7'0"	1453	1749	1749	1925
2134 x 1981	7'0" x 6'6"	1453	1749	1749	1925
2134 x 2134	7'0" x 7'0"	1475	1771	1771	1948
2286 x 1981	7'6" x 6'6"	1552	1815	1815	1992
2286 x 2134	7'6" x 7'0"	1591	1838	1838	2015
2438 x 1981	8'0" x 6'6"	1669	1882	1882	2060
2438 x 2134	8'0" x 7'0"	1693	1890	1890	2069

Made To Measure Sizes Take the next size up from the table Refer to the table below to confirm size availability

1981 x 1981	6'6" x 6'6"	1553	1849	1849	2025
1981 x 2134	6'6" x 7'0"	1553	1849	1849	2025
1981 x 2286	6'6" x 7'6"	1553	1849	1849	2025
2134 x 1981	7'0" x 6'6"	1553	1849	1849	2025
2134 x 2134	7'0" x 7'0"	1575	1871	1871	2048
2134 x 2286	7'0" x 7'6"	1575	1871	1871	2048
2286 x 1981	7'6" x 6'6"	1652	1915	1915	2092
2286 x 2134	7'6" x 7'0"	1691	1938	1938	2115
2286 x 2286	7'6" x 7'6"	1691	1938	1938	2115
2438 x 1981	8'0" x 6'6"	1769	1982	1982	2160
2438 x 2134	8'0" x 7'0"	1793	1990	1990	2169
2438 x 2286	8'0" x 7'6"	1793	1990	1990	2169

Options - add the supplement as listed

Finishes Light Oak, Mahogany, Walnut & Burnt Oak	195
Glazing Stippled Plain (Standard) / Square Lattice / Diamond Lattice	0
Frames Un-Framed deduct	40
65mm painted white, black, brown	20
Security & Draft Fur Pack	125
Left Hand Opening	55

	Side Hinged	Side Hinged	Side Hinged	Side Hinged
Minimum width mm	1524 5'0"	1524 5'0"	1524 5'0"	1524 5'0"
Maximum width mm	2438 8'0"	2438 8'0"	2438 8'0"	2438 8'0"
Minimum height mm	1829 6'0"	1829 6'0"	1829 6'0"	1829 6'0"
Maximum height mm	2286 7'6"	2286 7'6"	2286 7'6"	2286 7'6"

check list for all doors - use the list below to confirm the details of your door

Sizes listed are the ordering sizes. These are internal frame sizes, doors are built to allow clearance within these dimensions - see page 30 onwards for details.

All doors are complete with a 65mm frame

Doors are supplied with a lock hole unless specified otherwise.



Doors are outward opening only and with the lock on the right hand leaf when viewed from outside.



N.B. Check the information for your chosen style to ensure the sizes and options required are available.



ABS SIDE HINGED GARAGE DOORS

Bedford Black glazing as std



Regal



Senator



Tudor



Key:

The symbols denote sizing and window availability. Photographs show 2134mm x 2134mm doors. Feature size and spacing may vary for Intermediate sizes - If in doubt please refer to Cardale before ordering.

Prices shown with Prima Finish Frame

Standard Size Doors

width x height	Bedford		Regal		Senator		Tudor	
	Side Hinged	Side Hinged	Side Hinged	Side Hinged	Side Hinged	Side Hinged	Side Hinged	
2134 x 1981	7'0" x 6'6"	1316	1194	1234	1234			
2134 x 2134	7'0" x 7'0"	1316	1194	1234	1234			
2286 x 1981	7'6" x 6'6"	1402	1279	1316	1316			
2286 x 2134	7'6" x 7'0"	1402	1279	1316	1316			
2438 x 1981	8'0" x 6'6"	1485	1363	1402	1402			
2438 x 2134	8'0" x 7'0"	1485	1363	1402	1402			

Made to Measure Size Doors

Refer to the table at the foot of the page to confirm size availability

width x height

width x height	Bedford	Regal	Senator	Tudor
1981 x 1981	6'6" x 6'6"	1444	1316	1361
2134 x 1981	7'0" x 6'6"	1444	1316	1361
2134 x 2134	7'0" x 7'0"	1444	1316	1361
2134 x 2286	7'0" x 7'6"	1544	1416	1461
2286 x 1981	7'6" x 6'6"	1527	1402	1444
2286 x 2134	7'6" x 7'0"	1527	1402	1444
2286 x 2286	7'6" x 7'6"	1627	1502	1544
2438 x 1981	8'0" x 6'6"	1610	1485	1527
2438 x 2134	8'0" x 7'0"	1610	1485	1527
2438 x 2286	8'0" x 7'6"	1710	1585	1627

Options - add the supplement as listed

Glazing

Stippled Plain / Square Lattice / Diamond Lattice / Queen Anne Lattice **Regal & Senator Only**

220

Stippled Plain **Bedford Only**

100

Frames

Un-Framed deduct

40

65mm painted white, black, brown

20

Security & Draft Fur Pack

125

Left Hand Opening

55

	Side Hinged	Side Hinged	Side Hinged	Side Hinged
Minimum width mm	2032 6'8"	1861 5'11.5"	1981 6'6"	1987 6'6.25"
Maximum width mm	2438 8'0"	2438 8'0"	2438 8'0"	2438 8'0"
Minimum height mm	1861 6'1.25"	1902 6'2.8"	1829 6'0"	1895 6'2.6"
Maximum height mm	2223 7'3.5"	2261 7'5"	2261 7'5"	2200 7'2.6"

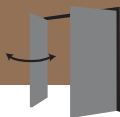

GRP SIDE HINGED DOORS

check list for all doors - use the list below to confirm the details of your door

Sizes listed are the ordering sizes. These are internal frame sizes, doors are built to allow clearance within these dimensions - see page 30 onwards for details.

All doors are complete with a 65mm frame

Doors are supplied with a lock hole unless specified otherwise.

- Doors are outward opening only and with the lock on the right hand leaf when viewed from outside.
- N.B.** Check the information for your chosen style to ensure the sizes and options required are available.
-

GRP SIDE HINGED GARAGE DOORS

Dorset Glasswhite



Cornwall Glasswood



Surrey Glasswood



Key:

The symbols denote sizing and window availability. Photographs show 2134mm x 2134mm doors. Feature size and spacing may vary for intermediate sizes - If in doubt please refer to Cardale before ordering.

Finishes:

Highly detailed, low maintenance timbergrain effect GRP doors available in twelve woodtone finishes.

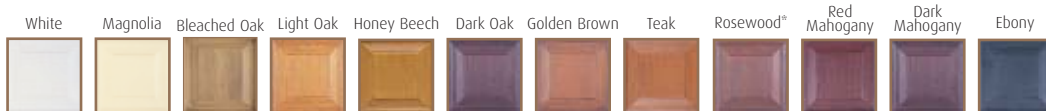

Premium - Rear view
The PREMIUM range has steel reinforcing laminated into the rear of the door for added strength and rigidity.



Deluxe - Rear view The DELUXE range features a double skin flat back construction with internal steel reinforcing. Doors over 10' wide feature external white powder coated steel horizontal stiffeners to the rear of the panel for increased rigidity. **Deluxe build doors are only available with black mock glazing.**

Prices shown with Premium Build & Prima Frame Side Hinged Standard Doors

width x height	Dorset		Surrey Cornwall	
	Side Hinged		Side Hinged	
2134 x 1981	7'0"	x 6'6"	1354	1427
2134 x 2134	7'0"	x 7'0"	1354	1427
2134 x 2286	7'0"	x 7'6"	1354	1427
2286 x 1981	7'6"	x 6'6"	1354	1427
2286 x 2134	7'6"	x 7'0"	1354	1427
2286 x 2286	7'6"	x 7'6"	1354	1427
2438 x 1981	8'0"	x 6'6"	1354	1427
2438 x 2134	8'0"	x 7'0"	1354	1427
2438 x 2286	8'0"	x 7'6"	1354	1427

Options - add the supplement as listed

	Side Hinged
Deluxe Build Black Mock Glazing Only	248
Glazing	
Stippled Plain / Clear Plain	255
Black / Smoked	125
Square Lattice / Diamond Lattice for above	0
Frames	
Un-Framed deduct	40
65mm painted white, black, brown	20
Security & Draft Fur Pack	125
Left Hand Opening	55

Made To Measure Sizes Take the next standard size up from the table above

	Side Hinged	Side Hinged
Minimum width mm	2134 7'0"	2134 7'0"
Maximum width mm	2438 8'0"	2438 8'0"
Minimum height mm	1981 6'6"	1981 6'6"
Maximum height mm	2286 7'6"	2286 7'6"



THERMAGLIDE ROLLER GARAGE DOORS

check list for all doors - use the list below to confirm the details of your door

Sizes listed are the ordering sizes. These are the over guide widths and guide heights - see page 30 onwards for details.



N.B. Check the information for your chosen style to ensure the sizes and options required are available.



THERMAGLIDE ROLLER GARAGE DOORS



Thermaglide Roller Door



Finishes:

Low maintenance Powdercoat or high grade woodgrain laminate

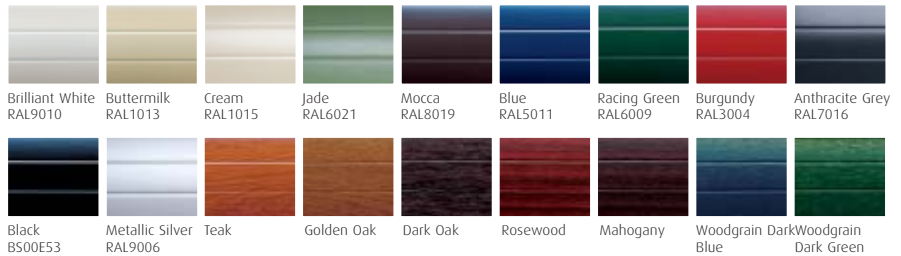

Please note that the colour of the bottom lath may vary slightly from the rest of the door. Teak doors are supplied with a solid brown bottom lath and guides.

Coloured Finish

New 2286mm (7'6") height band!

70mm guides (each side) and 270mm headroom

95mm guides (each side) and 300mm headroom

GUIDE HEIGHT (UP TO)	OVER GUIDE WIDTH (UP TO)						
	2000mm 6'6 3/4"	2500mm 8'2 3/8"	3000mm 9'10 1/8"	3500mm 11'5 3/4"	4000mm 13'1 1/2"	4600mm 15'1 1/8"	5200mm 17'0 3/4"
1981mm (6'6")	1130	1207	1325	1419	1617	1797	1999
2134mm (7'0")	1130	1207	1325	1419	1617	1797	1999
2286mm (7'6")	1165	1243	1360	1454	1715	1825	2115
2438mm (8'0")	1190	1268	1444	1479	1715	1945	2130
2590mm (8'6")	1291	1422	1522	1588	1885	2030	2325
2743mm (9'0")	1311	1442	1522	1588	1922	2250	2450
3000mm (9'10")	1311	1442	1565	1588	1922	2300	-

*Guide heights of over 2500mm supplied with 95mm guides

Woodgrain Finish

GUIDE HEIGHT (UP TO)	OVER GUIDE WIDTH (UP TO)						
	2000mm 6'6 3/4"	2500mm 8'2 3/8"	3000mm 9'10 1/8"	3500mm 11'5 3/4"	4000mm 13'1 1/2"	4600mm 15'1 1/8"	5200mm 17'0 3/4"
1981mm (6'6")	1326	1470	1640	1779	2044	2299	2547
2134mm (7'0")	1453	1470	1640	1779	2044	2300	2565
2286mm (7'6")	1495	1535	1705	1844	2099	2365	2630
2438mm (8'0")	1545	1570	1803	1904	2195	2525	2768
2590mm (8'6")	1685	1810	1922	2103	2425	2695	2905
2743mm (9'0")	1795	1810	1922	2103	2475	2695	3255
3000mm (9'10")	1835	1850	1922	2103	2475	2795	-

*Guide heights of over 2500mm supplied with 95mm guides

Options Add size supplement to door price

90° half curtain roll box*	104	109	121	132	144	156	170
Full curtain Roll Box*	159	166	187	210	233	260	286
Vision Slats	46	48	58	68	76	89	99

* Roll box requires 300mm endplates and 95mm guides

Options

Mill finished guides	-30
Emergency external manual override	121
Lockable Override Cover	34
Additional keyring handset (8 channel)	70
Wired up/down wall switch	22
Wireless up/down wall switch	66
Wired key switch	61
Wireless key switch	130
Wireless keypad	182
Wired door status indicator & switch	55
Photocell kit	118
Parking sensor kit	219
Auto-close module	55
Battery Backup doors < 11m ²	325
Battery Backup doors > 11m ²	401
Battery Backup bracket	28
Relay unit (gate control)	217
Touch up paint	28



Colour matched Roll boxes are available in White, Mocca, Buttermilk, Racing Green, Burgundy, Blue, Black, Cream, Jade, Anthracite Grey and Metallic Silver. Full roll box shown, 90° Half box also available. See surcharges as listed above (colour matching is included in the price of the roll box).

Half
90°

Full



THERMAGLIDE 55 ROLLER GARAGE DOORS

check list for all doors - use the list below to confirm the details of your door

Sizes listed are the ordering sizes. These are the over guide widths and guide heights - see page 30 onwards for details.



N.B. Check the information for your chosen style to ensure the sizes and options required are available.



THERMAGLIDE 55 ROLLER GARAGE DOORS

Thermaglide 55 Roller Door



Finishes:

Low maintenance Powdercoat or high grade woodgrain laminate



Brilliant White RAL9010 Mocca RAL8019 Cream RAL1015 Racing Green RAL6009 Black BS00E53 Metallic Bronze Metallic Silver Golden Oak Mahogany

Please note that the colour of the bottom lath may vary slightly from the rest of the door. Metallic Bronze doors are supplied with a solid brown bottom lath and guides.

Key:

The symbols denote sizing availability. Photographs show 2134mm x 2134mm doors.



White and Mocca only



Coloured Finish External fit

GUIDE HEIGHT (UP TO)	OVER GUIDE WIDTH (UP TO)				OVER GUIDE WIDTH (UP TO)			
	2134mm	2286mm	2450mm	3000mm	2134mm	2286mm	2450mm	3000mm
1981mm (6'6")	1342	1342	1342	1455	893	961	1019	1113
2134mm (7'0")	1342	1342	1342	1455	935	993	1040	1134
2438mm (8'0")	1445	1445	1445	1595	977	1035	1155	1208

Full roll box as standard

Full matching roll box and guides as standard

Coloured Finish Internal fit

GUIDE HEIGHT (UP TO)	OVER GUIDE WIDTH (UP TO)				OVER GUIDE WIDTH (UP TO)			
	2134mm	2286mm	2450mm	3000mm	2134mm	2286mm	2450mm	3000mm
1981mm (6'6")	1262	1262	1262	1375	893	961	1019	1113
2134mm (7'0")	1262	1262	1262	1375	935	993	1040	1134
2438mm (8'0")	1365	1365	1365	1515	977	1035	1155	1208

Full roll box as an option

Full matching roll box and guides as standard

Woodgrain Finish Internal fit

GUIDE HEIGHT (UP TO)	OVER GUIDE WIDTH (UP TO)			
	2134mm	2286mm	2450mm	3000mm
1981mm (6'6")	1490	1561	1561	1824
2134mm (7'0")	1490	1561	1561	1824
2438mm (8'0")	1712	1712	1712	1948

Full roll box as an option

Thermaglide 55 Manual is a spring assisted version of the Thermaglide 55. It includes a locking slat in the lower half of the door which is flat in profile and will vary slightly in colour from the curtain slats.

Options Thermaglide55 only (not Manual 55)

Full roll box on internal fit doors	Use External fit price
Colour matched guides*	0
Emergency external manual override	121
Lockable Override Cover	34
Additional keyring handset (8 channel)	70
Wired up/down wall switch	22
Wireless up/down wall switch	66
Wired key switch	61
Wireless key switch	130
Wireless keypad	182
Wired door status indicator & switch	55
Photocell kit	118
Parking sensor kit	219
Auto-close module	55
Battery Backup doors < 11m ²	325
Battery Backup bracket	28
Relay unit (gate control)	217
Touch up paint	28

* Woodgrain doors are only available with white, mocca, racing green, metallic silver, cream and black guides.

A full roll box is supplied as standard on external fit doors - specify colour with order.

A 90° half roll box is supplied as standard on internal fit doors (Manual 55 has a full roll box as standard) - specify colour with order.



Colour matched Roll boxes are available in White, Mocca, Racing Green, Black, Cream and Metallic Silver. Full roll box shown, supplied as standard on external fit doors, Half box supplied as standard on Internal fit doors.

Half 90°

Full



STEEL-LINE ROLLER GARAGE DOORS

check list for all doors - use the list below to confirm the details of your door

Sizes listed are the ordering sizes. These are the curtain sizes - see page 30 onwards for details.

Doors are designed to fit behind the reveal.



Doors are supplied with a lock hole unless specified otherwise.



N.B. Check the information for your chosen style to ensure the sizes and options required are available.



STEEL-LINE ROLLER GARAGE DOORS

Steel-line Roller Door



Finishes:

Low maintenance Leathergrain Plastisol or high grade woodgrain laminate

Leathergrain Plastisol Finishes

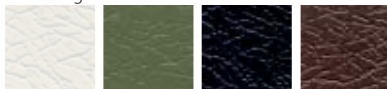

Brilliant White
BS00E55

Olive Green
BS12B27

Black
BS00E53

Van Dyke Brown
BS08B29



Golden Oak Rosewood

Weathergrain woodgrain
Laminate Finishes (requires
supplement - see table)



Steel-line standard headroom

Prices shown for Plastisol Finish

CURTAIN WIDTH 'A' SERIES = opening + 50mm (2")

CURTAIN WIDTH 'AA' SERIES = opening + 100mm (4")

WIDTH (MM) X HEIGHT (MM)	1270mm 4'2"	1880mm 6'2"	2185mm 7'2"	2335mm 7'7 1/8"	2490mm 8'2"	2640mm 8'7 1/8"	2800mm 9'2 1/4"	3100mm 10'2"	3400mm 11'1 1/8"	3760mm 12'4"	4370mm 14'4"	5100mm 16'8 3/4"
2134mm [-7'0"]	502	506	506	518	546	573	591	690	805	985	1131	1339
2135mm - 2438mm [>7'0" - 8'0"]	564	567	567	579	598	621	647	738	862	1077	1288	1458
2439mm - 2743mm [>8'0" - 9'0"]	614	634	634	653	687	703	727	823	941	1188	1344	1552
2744mm - 3048mm [>9'0" - 10'0"]	659	699	717	749	784	789	806	907	1061	1293	1476	1582
Weathergrain Finish add:	65	65	97	97	97	128	128	128	128	222	222	222



Steel-line Mini - reduced headroom requirement Prices shown for Plastisol Finish

2134mm [-7'0"]	-	510	510	525	545	565	585	-	-	-	-	-
Weathergrain Finish add:	-	65	97	97	97	128	128	-	-	-	-	-

Options - add the supplement as listed

Reverse Roll	74
Steel Wrap	86
Rollguard Security Package	146
Infil Panels Per linear metre	37
Removable Centre Mullions	93
Chain Kits (For high openings)	196

Made To Measure Sizes Take the next standard size up from the table above and add: **40**

Automation

Steel-line Slim Drive Operator **345**

Complete with two, multi-channel handsets. This motor is also suitable as retrofit.

Automation Options Steel-line Slim Drive

Additional Mini Transmitter 4 channel	59	Wireless Keypad	67
Electric Key Switch	32	Wireless Fingerprint Scanner	144
External Manual Release Kit	20	Motion detector Control Panel	40
Wireless Wall Control	48	Battery Backup System	136
Beam Break	48		

Ordering Notes

Steel-line doors are designed to fit behind the brickwork opening, allowing clear drive-through width*. Please therefore order by the curtain size, ensuring that the curtain width is greater than the opening by:

Series	Curtain width
'A' Series	Opening + 50mm (2") minimum
'AA' Series (solid areas)	Opening + 100mm (4") minimum
Rollguard (all doors)	Opening + 70mm (2 3/4") minimum

* The drive-through height is 80mm less than the nominal opening height.

Doors are packed with protective cardboard bands and shrink wrapped as standard. For packing options see table above. Bubble wrapping is a no cost option.

NEW!

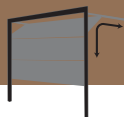

GRP SECTIONAL GARAGE DOORS

check list for all doors - use the list below to confirm the details of your door

Sizes listed are the ordering sizes - see page 30 onwards for details.



N.B. Check the information for your chosen style to ensure the sizes and options required are available.



Vienna White Gloss



Vienna Woodgrain



Oslo Woodgrain



Verona Woodgrain



Doors are available in three configurations:

Standard version- Double skin doors

"40" version - Insulating foam filled double skin doors

"DC" version - includes remote control opener to suit door size



Standard colour options



See options supplement for these colours

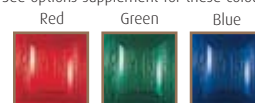

Standard Size Doors

G.R.P. Gloss White

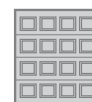
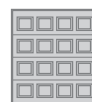
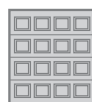
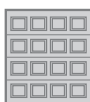

Width	VIENNA (DOUBLE SKIN)		VIENNA DC (+ REMOTE CONTROL)		VIENNA 40 (DOUBLE SKIN INSULATED)		VIENNA 40 DC INSULATED (+ REMOTE CONTROL)	
	Height 6'6" to 7'0" 1981 to 2134(mm)	Height >7'0" to 7'6" 2134 to 2286(mm)	Height 6'6" to 7'0" 1981 to 2134(mm)	Height >7'0" to 7'6" 2134 to 2286(mm)	Height 6'6" to 7'0" 1981 to 2134(mm)	Height >7'0" to 7'6" 2134 to 2286(mm)	Height 6'6" to 7'0" 1981 to 2134(mm)	Height >7'0" to 7'6" 2134 to 2286(mm)
2134mm (7'0")	1541	1670	1847	1977	1894	2023	2200	2329
2438mm (8'0")	1579	1710	1885	2016	1940	2071	2246	2378
2743mm (9'0")	1629	1754	1936	2061	1972	2098	2279	2405
3048mm (10'0")	1879	2004	2186	2310	2568	2693	2874	2999
3353mm (11'0")	2004	2130	2382	2508	2693	2819	3071	3197
3658mm (12'0")	2130	2255	2508	2633	2819	2944	3197	3322
3962mm (13'0")	2255	2380	2633	2758	2944	3070	3322	3448
4267mm (14'0")	2110	2233	2488	2611	2792	2915	3170	3293
4572mm (15'0")	2505	2630	2883	3008	3194	3320	3572	3698
4877mm (16'0")	2630	2755	3008	3133	3320	3443	3698	3821

G.R.P. Woodgrain



Width	VIENNA, OSLO, VERONA (DOUBLE SKIN)		VIENNA, OSLO, VERONA DC (+ REMOTE CONTROL)		VIENNA, OSLO, VERONA 40 (DOUBLE SKIN INSULATED)		VIENNA, OSLO, VERONA 40 DC (+ REMOTE CONTROL)	
	Height 6'6" to 7'0" 1981 to 2134(mm)	Height >7'0" to 7'6" 2134 to 2286(mm)	Height 6'6" to 7'0" 1981 to 2134(mm)	Height >7'0" to 7'6" 2134 to 2286(mm)	Height 6'6" to 7'0" 1981 to 2134(mm)	Height >7'0" to 7'6" 2134 to 2286(mm)	Height 6'6" to 7'0" 1981 to 2134(mm)	Height >7'0" to 7'6" 2134 to 2286(mm)
2134mm (7'0")	1670	1798	1977	2105	2023	2150	2329	2456
2438mm (8'0")	1710	1842	2016	2149	2071	2203	2378	2510
2743mm (9'0")	1754	1879	2061	2186	2098	2222	2405	2529
3048mm (10'0")	2004	2130	2310	2436	2693	2819	2999	3125
3353mm (11'0")	2130	2255	2508	2633	2819	2944	3197	3322
3658mm (12'0")	2255	2380	2633	2758	2944	3070	3322	3448
3962mm (13'0")	2380	2505	2758	2883	3070	3194	3448	3572
4267mm (14'0")	2240	2363	2618	2741	2923	3045	3301	3423
4572mm (15'0")	2630	2755	3008	3133	3320	3443	3698	3821
4877mm (16'0")	2755	2881	3133	3259	3443	3569	3821	3947

Made to Measure Take the next size up from the tables above, available in widths: 2083 to 4877 (6'10" to 16'0") & heights 1981 to 2286 (6'6" to 7'6")

OPTIONS

Manual locking	44
Black windows on Vienna doors up to 2438mm (8'0") wide / over 2438mm (8'0") wide (please specify leading requirements)	125 / 250
Porthole Windows (Per window) Oslo only (330mm overall diameter, 250mm glazed diameter)	250
Colour Option available for Woodgrain doors only - blue, green and red - for doors up 2438mm (8'0") wide / doors over 2438mm (8'0") wide	250 / 370

OPTIONS FOR DC SPECIFICATION DOORS

Beam break	70	Emergency exterior release kit	31	Exterior keyless digital entry pad	93
Chain Drive	0	External receiver	102	Mini transmitter (4 channel)	49
Kevlar Belt drive	48	Three function wall control	37	Two piece extended toothed belt / chain drive boom	21
DC800NII upgrade (for doors up to 3048mm (10'))	68			Two piece extended Kevlar belt drive boom	74

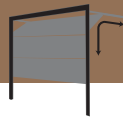

THERMALIFT 42 SECTIONAL GARAGE DOORS

check list for all doors - use the list below to confirm the details of your door

Sizes listed are the ordering sizes - see page 30 onwards for details.



N.B. Check the information for your chosen style to ensure the sizes and options required are available.



THERMALIFT 42 SECTIONAL GARAGE DOORS

Thermalift 42 Georgian



Finishes:

Low maintenance Powdercoat



Triang White



Triang Brown



Painted Oak



Embossed Woodgrain White*
*Not available on the Georgian style

High grade woodgrain laminate



Embossed Woodgrain Golden Oak

RAL colour finishes - any RAL colour - some popular finishes are shown - note- black no problem!



Clay Brown RAL8003



Light Grey RAL7035



Cream RAL9001



White Aluminium RAL9006



Moss Green RAL6005



Anthracite Grey RAL7016



Black RAL9005

WINDOW OPTIONS



Standard



Georgian



Georgian Insert



Envelope

Thermalift 42 Minirib



Thermalift 42 Midirib



Thermalift 42 Flush



Options add to the price of your door from the right hand page

Finishes Sectional Doors (all doors are Triang white as standard and white on the inside)

Fully finished brown	0
Fully finished to a RAL colour per metre ²	45
Golden Oak embossed woodgrain doors up to and including 3000mm wide	150
Golden Oak embossed woodgrain doors over 3000mm wide	275
White embossed woodgrain (Minirib, Midirib and Flush styles only)	0

Finishes Side Doors (all doors are Triang white as standard and white on the inside)

Fully finished brown	0
Fully finished to a RAL colour	85

Frames

Frame section for within the reveal fitting (doors up to and including 2375mm high. Includes twin frame legs and fixings)	35
---	----

Windows

Doors up to 3000mm wide specify Clear or milky glass & Standard, Georgian, Envelope or Georgian Insert with order. Cassettes painted to match door colour	243
Doors over 3000mm wide specify Clear or milky glass & Standard, Georgian, Envelope or Georgian Insert with order. Cassettes painted to match door colour	485

Side doors 65

Handles

Manual locking Kit (Includes black plastic handle and locking system for on-site fitting with template supplied)	30
Silver handle upgrade	37
Gold effect handle upgrade	86
Stainless Steel handle upgrade	115

Gear

Low headroom tension or torsion kits for standard size doors up to and including 3000mm wide*	82
Torsion kits for standard size doors over 3000mm wide*	82

*All doors with heights of 2650, 2800 and 3000mm are supplied with low headroom torsion gear as standard. See table and note on the right hand page for gear options available with made to measure doors

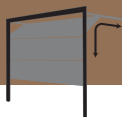

THERMALIFT 42 SECTIONAL GARAGE DOORS

Standard Single Doors

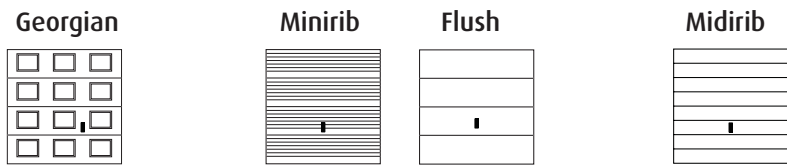

WIDTH X HEIGHT	Georgian			Minirib			Flush			Midirib		
	Tension Gear	Torsion Gear	Emboss x Panels	Tension Gear	Torsion Gear	Emboss x Panels	Tension Gear	Torsion Gear	Emboss x Panels	Tension Gear	Torsion Gear	Emboss x Panels
2134 x 2000 (7'0" x 6'6")	1031	1081	3x4	848	898	4	1049	1099	4			
2134 x 2125 (7'0" x 7'0")	1041	1091	3x4	848	898	4	1049	1099	4			
2286 x 2000 (7'6" x 6'6")	1120	1170	3x4	871	921	4	1098	1148	4			
2286 x 2125 (7'6" x 7'0")	1120	1170	3x4	889	939	4	1121	1171	4			
2438 x 2000 (8'0" x 6'6")	1137	1187	3x4	894	944	4	1098	1148	4			
2438 x 2125 (8'0" x 7'0")	1137	1187	3x4	894	944	4	1121	1171	4			
2591 x 2000 (8'6" x 6'6")	1205	1255	4x4	929	979	4	1145	1195	4			
2591 x 2125 (8'6" x 7'0")	1205	1255	4x4	929	979	4	1168	1218	4			
2743 x 2000 (9'0" x 6'6")	1254	1304	4x4	953	1003	4	1145	1195	4			
2743 x 2125 (9'0" x 7'0")	1254	1304	4x4	953	1003	4	1168	1218	4			
2895 x 2000 (9'6" x 6'6")	1397	1447	4x4	998	1048	4	1199	1249	4			
2895 x 2125 (9'6" x 7'0")	1397	1447	4x4	998	1048	4	1222	1272	4			

Standard Double Doors

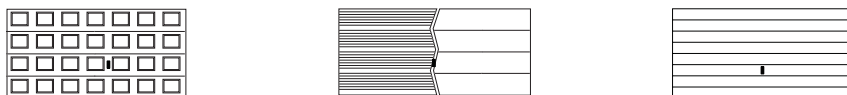

WIDTH X HEIGHT	Georgian			Minirib			Midirib		
	Tension Gear	Torsion Gear	Emboss x Panels	Tension Gear	Torsion Gear	Emboss x Panels	Tension Gear	Torsion Gear	Emboss x Panels
3048 x 2000 (10'0" x 6'6")	-	1667	4x4	-	1197	4	-	1503	4
3048 x 2125 (10'0" x 7'0")	-	1667	4x4	-	1218	4	-	1529	4
3658 x 2000 (12'0" x 6'6")	-	1827	6x4	-	1505	4	-	1589	4
3658 x 2125 (12'0" x 7'0")	-	1827	6x4	-	1505	4	-	1618	4
3962 x 2000 (13'0" x 6'6")	-	1827	6x4	-	1536	4	-	1704	4
3962 x 2125 (13'0" x 7'0")	-	1827	6x4	-	1536	4	-	1735	4
4267 x 2000 (14'0" x 6'6")	-	1827	7x4	-	1471	4	-	1854	4
4267 x 2125 (14'0" x 7'0")	-	1827	7x4	-	1499	4	-	1889	4
4420 x 2000 (14'6" x 6'6")	-	1859	7x4	-	1532	4	-	1854	4
4420 x 2125 (14'6" x 7'0")	-	1889	7x4	-	1532	4	-	1889	4
4876 x 2000 (16'0" x 6'6")	-	1939	7x4	-	1682	4	-	1939	4
4876 x 2125 (16'0" x 7'0")	-	1979	7x4	-	1682	4	-	1978	4

Made To Measure sizes - all styles

HEIGHT	WIDTH	1800	2000	2250	2500	2750	3000	3250	3500	3750	4000	4250	4500	4750	5000	PANELS
1900															POA	4
2000		Take the next size up from the tables above and add £90													POA	4
2125															POA	4
2250		Take the next width up and add £300 to the 2125 height price from the tables above													POA	4
2375															POA	5
2500															POA	5
2650		Take the next width up and add £500 to the 2125 height price from the tables above														5
2800															Not available at these sizes	5
3000																6

NUMBER OF EMBOSSES PER DOOR PANEL up to 2399mm = 3 up to 3099mm = 4 up to 3649mm = 5 up to 4249mm = 6 up to 5000mm = 7

Side Doors**

Standard sizes

SIZE	OUTSIDE FRAME SIZE	Georgian Minirib Flush		
WIDTH X HEIGHT	WIDTH X HEIGHT			
875 x 2000	1011 x 2068	646	548	548
875 x 2125	1011 x 2193	646	548	548
1000 x 2000	1136 x 2068	671	574	574
1000 x 2125	1136 x 2193	671	574	574

Made To Measure sizes

714-964 x 1935-2032	850-1100 x 2003-2100	686	588	588
965-1114 x 2033-2135	1101-1250 x 2101-2203	711	614	614



Doors in this green shaded area (up to 3000mm wide x 2500mm high) are supplied with standard tension gear
 For low headroom tension gear:- Add £82 to the prices shown
 For torsion gear:- Add £82 to the prices shown
 For low headroom torsion gear:- Add £145 to the prices shown

Doors in the purple shaded area are supplied with standard torsion gear
 For low headroom torsion gear Add £82 to the prices shown

Doors in the blue shaded area are supplied with low headroom torsion gear as standard



** Side doors can be supplied for opening to the left or right and to the inside or outside. Please state handing viewed from the outside. Inward opening door, handle on the left (hinges on the right) = left handed. Outward opening door, handle on the left (hinges on the right) = right handed. All doors are supplied with a black aluminium handle and eurocylinder lock as standard. Side doors are available in White (RAL 9016) or in Brown (RAL 8014) or to a RAL specification. The inside of the door is always white. The panel thickness is 42mm.



AUTOGLIDE



DC-550NIII



DC-650NIII



DC-800NIII

Toothed cable supplied as standard

OPERATION TYPE

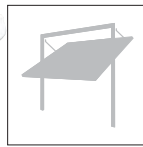

Canopy

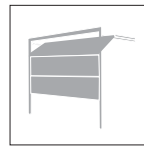

Sectional

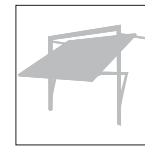

Retractable



Side Hinged

Operator

Operator	Canopy	Sectional	Retractable	Side Hinged
Autoglide (with one 2 channel handset)	550	-	-	-
AutoEntry DC550NIII (with two 4 channel handsets)	-	357	357	-
Toothed Cable Drive 2475mm travel doors up to 14" x 7'0"	-	430	430	-
AutoPro DC650NIII (with two 4 channel handsets)	-	473	473	-
Toothed Cable Drive 2590mm travel doors up to 14" x 7'0"	-	473	473	-
AutoPro DC800NIII (with two 4 channel handsets)	-	-	-	-
Toothed Cable Drive 2590mm travel doors up to 18" x 7'0"	-	-	-	-

Options

1 piece medium boom Toothed Cable Drive	2840mm travel [†]	-	21	21	-
1 piece standard boom Chain Drive	2590mm travel [†]	-	0	0	-
1 piece medium boom Chain Drive	2840mm travel [†]	-	21	21	-
1 piece long boom Chain Drive	3600mm travel [†]	-	53	53	-
1 piece standard boom Kevlar Belt Drive	2590mm travel [†]	-	48	48	-
1 piece medium boom Kevlar Belt Drive	2840mm travel [†]	-	74	74	-
1 piece long boom Kevlar Belt Drive	3600mm travel [†]	-	95	95	-
2 piece boom option for all drive types		-	0	0	-
Beam break		-	70	70	-
Electric key switch control	41	41	41	41	-
Exterior digital keyless entry pad	87	93	93	93	-
Exterior release kit for power failure entry	36	31	31	31	-
External receiver	-	102	102	102	-
Light relay	-	70	70	70	-
Mini keyring hand transmitter 433 mHz	59	-	-	-	-
Mini transmitter (4 channel 868 mHz)	-	49	49	49	-
Wireless surface mounted interior 2 channel push button	-	49	49	49	-
Wired Surface mounted interior paddle switch	-	11	11	11	-
Three function wall control	-	37	37	37	-
Parking Sensor Kit	-	219	219	219	-
Henderson conversion Kit (premier/pre-premier)	54 / 41	-	-	-	-
Garador Mark III 'C' type gear conversion Kit	36	-	-	-	-

[†]2475 travel on AutoEntry DC550NIII * Recommended for use with AutoPro DC650NIII and AutoPro DC800NIII operators only



FEATURE	AUTOGLIDE	AUTOENTRY DC550NIII	AUTOPRO DC650NIII	AUTOPRO DC800NIII
DOOR SUITABILITY	SafeLift Canopy gear* and CD45 & CD Professional Trackless Canopy gear retro fit	Slideaway	Slideaway	Slideaway
OPENING FORCE	400N	550N with electronic 'Soft Start & Stop'	650N electronic adjustable 'Soft Start & Stop'	800N electronic adjustable 'Soft Start & Stop'
NORMAL RUNNING LOAD	60W (energy saving circuit) plus 120W light output	200W max (with 230V, 40 Watt light on)	200W max (with 230V, 40 Watt light on)	250W max (with 230V, 40 Watt light on)
'STAND-BY' LOAD	7 Watts (energy saving circuit)	<4 Watts (energy saving circuit)	<4 Watts (energy saving circuit)	<4 Watts (energy saving circuit)
MOTOR	24V DC with thermal overload protection on transformer	24V DC with thermal overload protection on transformer	24V DC with thermal overload protection on transformer	24V DC with thermal overload protection on transformer
CHIPSET	Smart Entry System auto-calibrating motherboard with LED diagnostics	Smart Entry System auto-calibrating motherboard with LED diagnostics	Smart Entry System auto-calibrating motherboard with Numerical Display diagnostics	Smart Entry System auto-calibrating motherboard with Numerical Display diagnostics
DRIVE METHOD	Dymetrol belt	Cable & Tooth (Chain or Kevlar Belt Option)	Cable & Tooth (Chain or Kevlar Belt Option)	Cable & Tooth (Chain or Kevlar Belt Option)
SAFETY DOOR REVERSE	To fully open position	To fully open position	Adjustable: 30cm of fully open position	Adjustable: 30cm of fully open position
LIGHT	120W maximum, can be positioned away from operator (bulb & cabling not included)	Integral 240V fitting with diffuser cover. 40W maximum	Integral 240V fitting with diffuser cover. 40W maximum	Integral 240V fitting with diffuser cover. 40W maximum
STANDARD BOOM	1 piece, sits on RHS of door frame	1 piece 'C' channel with 2475mm carriage travel – total operator length 3331mm	1 piece 'C' channel with 2590mm carriage travel – total operator length 3353mm	1 piece 'C' channel with 2590mm carriage travel – total operator length 3353mm
EXTENDED BOOM (OPTIONAL)	N/A	1 or 2 piece 'C' channel with 2725mm or 3485mm carriage travel	1 piece assembled or 2 piece semi assembled C-channel with 2840mm or 3600mm carriage travel	1 piece assembled or 2 piece semi assembled C-channel with 2840mm or 3600mm carriage travel
SUITABLE POSITION FOR MAINS SOCKET	Suitable height from floor on RHS of garage within 1000mm of operator unit	800mm from end of boom. Measured from operator head end of boom travel – total operator length 3331mm	800mm from end of boom. Measured from operator head end of boom travel – total operator length 3353mm	800mm from end of boom. Measured from operator head end of boom travel – total operator length 3353mm
DOOR SIZE SUITABILITY	Up to 2438 x 2134mm (80" x 70"). Min height 1930mm (6'4")	All doors up to 4267 x 2134mm (140" x 70"), or 3048mm (100") high with extended boom	All doors up to 4267 x 2134mm (140" x 70"), or 3048mm (100") high with extended boom	All doors up to 4267 x 2134mm (140" x 70"), or 3048mm (100") high with extended boom
HEADROOM REQUIRED	None	30mm	30mm	30mm
SIDEROOM REQUIRED	70mm on RHS of door	None	None	None
MANUAL DISCONNECT	Yes	Yes	Yes	Yes
RADIO RECEIVER	Internal digital, auto-learning rolling code	Digital module. Easy to exchange for other frequency (ie. 433MHz. for Homelink)	Digital module. Easy to exchange for other frequency (ie. 433MHz. for Homelink)	Digital module. Easy to exchange for other frequency (ie. 433MHz. for Homelink)
RADIO TRANSMITTER	1 x Digital 433 MHz two button mini handset, rolling code (1 billion variations)	2 x digital 868 MHz four button mini handsets, with multibit coding (281 billion variations)	2 x digital 868 MHz four button mini handsets, with multibit coding (281 billion variations)	2 x digital 868 MHz four button mini handsets, with multibit coding (281 billion variations)
TRANSMITTER RANGE	10 – 30 metres	10 – 50 metres	10 – 50 metres	10 – 50 metres
BELL PUSH BUTTON	Yes	No	No	No

*Adaptor kits available for Henderson doors built after 1987 and Garador Mk III 'C' type gear.

FRAMES, WINDOWS & ACCESSORIES

FRAMES FOR UP&OVER/SIDE HINGED GARAGE DOORS & PERSONNEL DOORS

Steel frames are available in Primed, White Plastisol, Van Dyke Brown Plastisol and Black Plastisol, Weathergrain Golden Oak, Weathergrain Rosewood - please specify with order.

Frame Dimensions

Sizes code	Canopy steel 54 mm frame	Canopy steel 68 mm frame	Retractable single steel 68 mm frame	Retractable double steel 68 mm frame	Side hinged & Personnel steel 65 mm frame
A	54 mm	68 mm	68 mm	68 mm	65 mm
B	68 mm	68 mm	68 mm	68 mm	68 mm
C	35 mm	35 mm	60 mm	75 mm	68 mm

NOTE

Single frames are up to 8'0" wide. Please state whether the frame is required pre-fitted to the door or as a knock-down kit. Double frames are from 8'0" to 16'0" wide. All Double door frames are supplied as a knock-down kit for assembly on site.

All single doors over 7'6" high will be supplied with a knock-down frame kit.

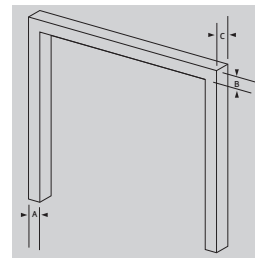

WINDOWS

STEEL

Selected steel doors are available with the following window designs - see pricing for window types available with each door style. Please specify your chosen design with your order.



TIMBER

Selected timber doors are available with the following window designs - see pricing for window types available with each door style. Please specify your chosen design with your order.



ABS

Selected ABS doors are available with the following window designs - see pricing for window types available with each door style. Please specify your chosen design with your order.



GRP

Selected GRP doors are available with the following window designs - see pricing for window types available with each door style. Please specify your chosen design with your order.



ROLLER

Thermaglidle Roller doors can be supplied with vision slots to a limited number of laths - please call for details - see roller section for pricing.



SECTIONAL

Thermalift 42 Sectional doors can be supplied with windows normally installed to the top panel of the door - see sectional doors on pages 26 & 27 for pricing. Selected styles GRP Sectional doors are available with glazing - see page 25 for details.



NOTES FOR ALL WINDOWS

Plain black windows are decorative only and do not allow any light into the garage. Clear windows are see-through and allow light into a garage. Stippled windows allow light into the garage but are not see-through. Please note that the glazing images shown represent the internal view, where the 'stained glass' effect is greatest - e.g. as in a church. From the outside, the appearance may be muted.

The glazed panels are constructed from shatter resistant polycarbonate with stippled, translucent anti-reflectant finish (GRP doors with the clear option use a clear polycarbonate). On Glasswhite and Glasswood GRP doors the glazed panel may be constructed from translucent resin and mat substrate.

Windows for Thermalift 42 sectional doors are double glazed in a 'sandwich' construction with PVCu frame.

HANDLES

UP & OVER DOORS



BLACK

Black handle as standard on Steel doors



BLACK

Black handle as standard on GRP, ABS & Timber Futura / Heritage.



BRASS EFFECT

Optional on GRP, ABS & Timber Futura / Heritage. - see door pricing for availability.

THERMALIFT 42 SECTIONAL DOORS



MANUAL LOCKING

A manual locking Kit which includes a black plastic handle and locking system for on-site fitting (template supplied) alternative handle finishes are available as shown left - see pages 26-27 for pricing

GRP SECTIONAL DOORS



MANUAL LOCKING

A manual locking Kit which includes a black handle and locking system for on-site fitting.

SIDE HINGED & PERSONNEL DOORS



BRASS EFFECT

A Brass effect finger pull is supplied with side hinged and personnel doors.

SECURITY PACK

A security and draft fur pack with three point locking for the active leaf and "monkey fur" draft sealing is available as an option on side hinged doors. Personnel doors are available with three point locking and "monkey fur" draft sealing.

DRAFT STRIP



A bottom edge brushstrip is available to fit all Cardale up & over doors. Ideal for uneven floor surfaces, the brushstrip will help to prevent leaves, dirt and drafts blowing into your garage.

£ 39 single doors £ 75 double doors

SAFELIFT CANOPY GEAR



STANDARD DOOR AND BRICKWORK APERTURE SIZES

- It is recommended that SafeLift Canopy is fitted to a weatherbeaded 70 mm x 70 mm timber "goalpost" frame, although the door can be fitted to a smaller side jamb down to a minimum of 45 mm wide. This frame is not supplied. A Cardale Quick-fit steel frame can also be used. Safelift Canopy steel frame dimensions are 54 mm wide on side section, 68 mm high on top section and 35 mm deep all round, plus there is also an option of a 68 mm wide side jamb.
- The minimum headroom required above the lower face of the top timber or lintel is 65 mm.

NOTES

Door sizes given represent opening sizes within the frame. Door leaves are approximately 19 mm narrower and 25 mm shorter to allow for operating clearances and tolerances. 'Within the brickwork' aperture dimensions include a 3 mm gap between the frame and brickwork on all three sides to allow for coursing and tolerances. 'Behind the brickwork' aperture dimensions allow the frame to overlap into the aperture by a minimum of 13 mm on both sides to allow for coursing and tolerances.

BRICKWORK APERTURE SIZES FOR FRAMES FITTED WITHIN THE OPENING

Size code	Door size	Timber frame (70x70mm)	54mm Quick-fit steel frame	68mm Quick-fit steel frame
	width x height	Brickwork aperture width x height	Brickwork aperture width x height	Brickwork aperture width x height
6666	1981 x 1981mm	2127 x 2054mm	2095 x 2052mm	2123 x 2052mm
6670	1981 x 2134mm	2127 x 2207mm	2095 x 2205mm	2123 x 2205mm
7066	2134 x 1981mm	2280 x 2054mm	2248 x 2052mm	2276 x 2052mm
7070	2134 x 2134mm	2280 x 2207mm	2248 x 2205mm	2276 x 2205mm
7364	2222 x 1930mm	2368 x 2003mm	2336 x 2001mm	2364 x 2001mm
7566	2261 x 1981mm	2407 x 2054mm	2375 x 2052mm	2403 x 2052mm
7570	2261 x 2134mm	2407 x 2207mm	2375 x 2205mm	2403 x 2205mm
7666	2286 x 1981mm	2432 x 2054mm	2400 x 2052mm	2428 x 2052mm
7670	2286 x 2134mm	2432 x 2207mm	2400 x 2205mm	2428 x 2205mm
8066	2438 x 1981mm	2584 x 2054mm	2552 x 2052mm	2580 x 2052mm
8070	2438 x 2134mm	2584 x 2207mm	2552 x 2205mm	2580 x 2205mm

BRICKWORK APERTURE SIZES FOR FRAMES FITTED BEHIND THE OPENING

Size code	Door size	Timber frame (70x70mm)	54mm Quick-fit steel frame	68mm Quick-fit steel frame
	width x height	Brickwork aperture width x height	Brickwork aperture width x height	Brickwork aperture width x height
6666	1981 x 1981mm	2007 x 1981mm	2007 x 1981mm	2007 x 1981mm
6670	1981 x 2134mm	2007 x 2134mm	2007 x 2134mm	2007 x 2134mm
7066	2134 x 1981mm	2160 x 1981mm	2160 x 1981mm	2160 x 1981mm
7070	2134 x 2134mm	2160 x 2134mm	2160 x 2134mm	2160 x 2134mm
7364	2222 x 1930mm	2248 x 1930mm	2248 x 1930mm	2248 x 1930mm
7566	2261 x 1981mm	2287 x 1981mm	2287 x 1981mm	2287 x 1981mm
7570	2261 x 2134mm	2287 x 2134mm	2287 x 2134mm	2287 x 2134mm
7666	2286 x 1981mm	2312 x 1981mm	2312 x 1981mm	2312 x 1981mm
7670	2286 x 2134mm	2312 x 2134mm	2312 x 2134mm	2312 x 2134mm
8066	2438 x 1981mm	2464 x 1981mm	2464 x 1981mm	2464 x 1981mm
8070	2438 x 2134mm	2464 x 2134mm	2464 x 2134mm	2464 x 2134mm

FITTING FRAMES TO THE BRICKWORK

Frames may be fitted within or behind the brickwork. Fitting behind the brickwork, if the garage length allows, will increase the drive-through width by up to 114 mm (4 1/2").

A 19 mm x 19 mm weatherbead should always be fitted to the under-side of the door frame lintel in front of the door to hide the top gap. This feature is integral on the Cardale Quick-fit steel frame.

Where an Autoglide electric operator is to be specified together with a Cardale Quick-fit 54mm Safelift Canopy steel frame, the frame must be fitted behind the brickwork. This is not necessary with a 70 mm x 70 mm timber frame or the optional 68 mm steel frame.

Safelift Canopy doors are quick and easy to install and take up less space in the garage when opening.

Safelift Canopy lifting gear is available for single sized doors up to 2438 mm (8'0") wide and 2134 mm (7'0") high only.

TECHNICAL INFORMATION SAFELIFT CANOPY GEAR

SAFELIFT CANOPY GEAR

Fitting to timber frame, **within the brickwork aperture**

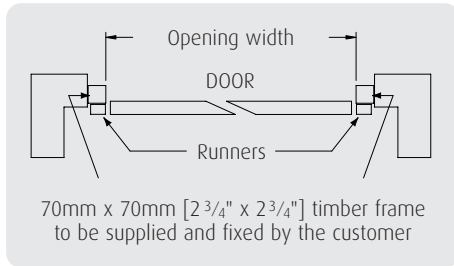

Fitting to timber frame, **behind the brickwork aperture**

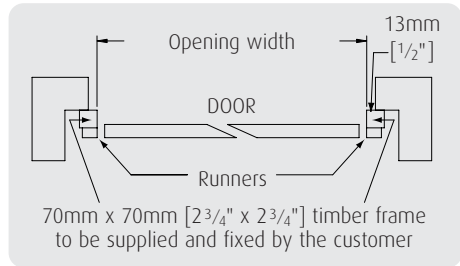

Fitting to Cardale 54 mm Quick-fit steel Safelift frame, **within the brickwork aperture**

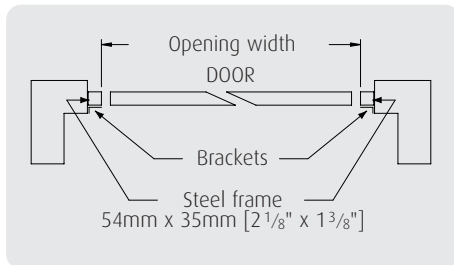

Fitting to Cardale 54 mm Quick-fit steel Safelift frame, **behind the brickwork aperture**

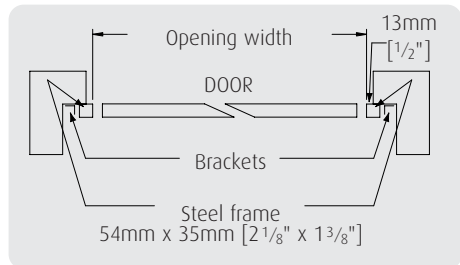

Fitting to Cardale 68 mm Quick-fit steel Safelift frame, **within the brickwork aperture**

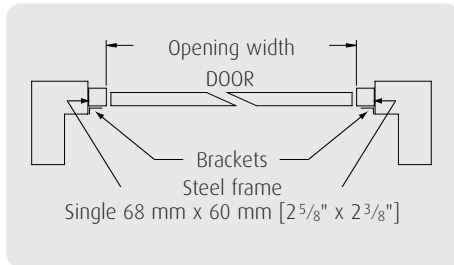

Fitting to Cardale 68mm Quick-fit steel Safelift frame, **behind the brickwork aperture**

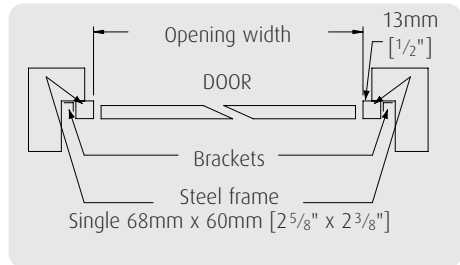

OPENING ARCS OF TRAVEL

Cardale 1981 mm [6'6"] high Safelift Trackless Canopy doors

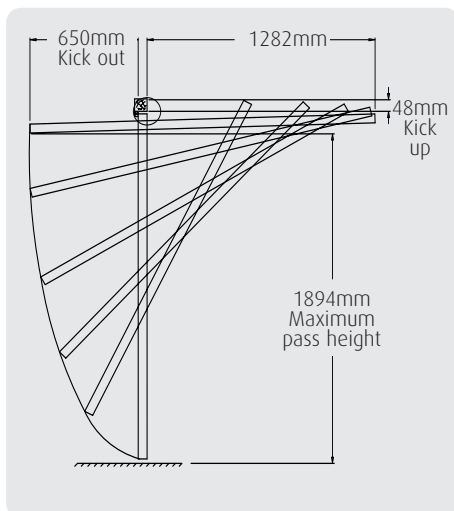

Cardale 2134 mm [7'0"] high Safelift Trackless Canopy doors

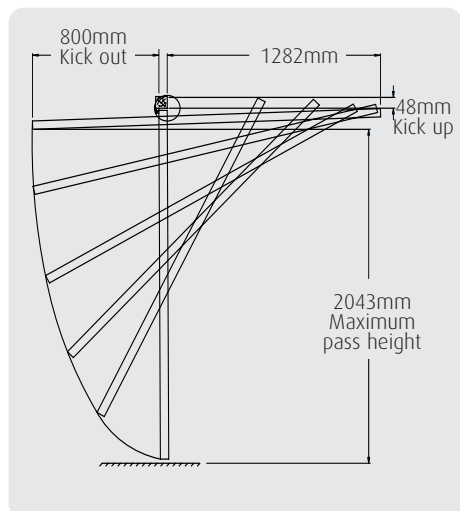

SLIDEAWAY RETRACTABLE GEAR MAXIMIZER II® RETRACTABLE GEAR

STANDARD DOOR AND BRICKWORK APERTURE SIZES

- Cardale Slideaway Retractable door gear should be fitted to a weatherbeaded 70 mm x 70 mm standard timber 'goalpost' frame (not supplied). Alternatively Slideaway single and double doors up to 4876 mm may be fitted to a Cardale Quick-fit steel Slideaway frame (single door dimensions = 68 mm wide by 60 mm deep all round, double door dimensions = 68 mm wide x 75 mm deep all round).
- The minimum headroom required above the lower face of the top timber or lintel is 43 mm for double doors, 38.5 mm for single doors.
- Optional Maximiser II retractable lifting gear is available for single sized Cardale doors up to 2438 mm (8'0") wide by 2286 mm (7'6") high only.

NOTES

- Door sizes given are for opening sizes within the frame. Door leaves are approximately 19 mm narrower and 25 mm shorter than the dimensions given to allow for clearances and tolerances.
- In use, single and double slideaway lifting gear reduces drive through width by 114 mm (4 1/2") and height by 127 mm (5"). With optional Maximizer II gear there is no reduction in drive through width up to 1050 mm from the ground on 1981 mm high doors (1200 mm on 2134 mm high doors), and only an 80 mm reduction in height.
- 'Within the brickwork' aperture dimensions include a 3 mm gap between the frame and brickwork on all three sides to allow for coursing and tolerances.
- 'Behind the brickwork' aperture dimensions allow the frame to overlap into the aperture by 13 mm on both sides to allow for coursing and tolerances.
- Slideaway frames for single and double doors are also available 7'6" high for single doors and 8'0" high for double doors.
- Special size frames are available in any size from 6'6" x 6'1" to 16' 0" x 8'0".

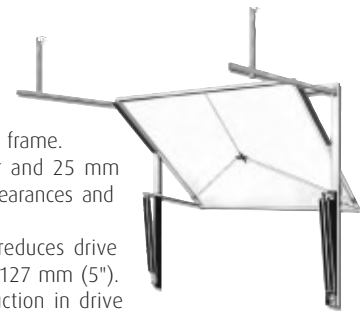

BRICKWORK APERTURE SIZES FOR FRAMES FITTED WITHIN THE OPENING

Size	Door size	Timber frame (70x70mm)	Quick-fit steel frame
		Brickwork aperture	Brickwork aperture
6666	1981 x 1981mm	2127 x 2054mm	2123 x 2052mm
6670	1981 x 2134mm	2127 x 2207mm	2123 x 2205mm
7066	2134 x 1981mm	2280 x 2054mm	2276 x 2052mm
7070	2134 x 2134mm	2280 x 2207mm	2276 x 2205mm
7364	2222 x 1930mm	2368 x 2003mm	2364 x 2001mm
7566	2261 x 1981mm	2407 x 2054mm	2403 x 2052mm
7570	2261 x 2134mm	2407 x 2207mm	2403 x 2205mm
7666	2286 x 1981mm	2432 x 2054mm	2428 x 2052mm
7670	2286 x 2134mm	2432 x 2207mm	2428 x 2205mm
8066	2438 x 1981mm	2584 x 2054mm	2580 x 2052mm
8070	2438 x 2134mm	2584 x 2207mm	2580 x 2205mm
1466	4267 x 1981mm	4413 x 2054mm	4413 x 2052mm
1470	4267 x 2134mm	4413 x 2207mm	4413 x 2205mm

BRICKWORK APERTURE SIZES FOR FRAMES FITTED BEHIND THE OPENING

Size	Door size	Timber frame (70x70mm)	Quick-fit steel frame
		Brickwork aperture	Brickwork aperture
6666	1981 x 1981mm	2007 x 1981mm	2007 x 1981mm
6670	1981 x 2134mm	2007 x 2134mm	2007 x 2134mm
7066	2134 x 1981mm	2160 x 1981mm	2160 x 1981mm
7070	2134 x 2134mm	2160 x 2134mm	2160 x 2134mm
7364	2222 x 1930mm	2248 x 1930mm	2248 x 1930mm
7566	2261 x 1981mm	2287 x 1981mm	2287 x 1981mm
7570	2261 x 2134mm	2287 x 2134mm	2287 x 2134mm
7666	2286 x 1981mm	2312 x 1981mm	2312 x 1981mm
7670	2286 x 2134mm	2312 x 2134mm	2312 x 2134mm
8066	2438 x 1981mm	2464 x 1981mm	2464 x 1981mm
8070	2438 x 2134mm	2464 x 2134mm	2464 x 2134mm
1466	4267 x 1981mm	4293 x 1981mm	4293 x 1981mm
1470	4267 x 2134mm	4293 x 2134mm	4293 x 2134mm

SLIDEAWAY

DRIVE-THROUGH CLEARANCES

(Double sized Slideaway doors up to 4876 mm (16' 0") wide by 2286 mm (7'6") high only & single Euro Oak doors)

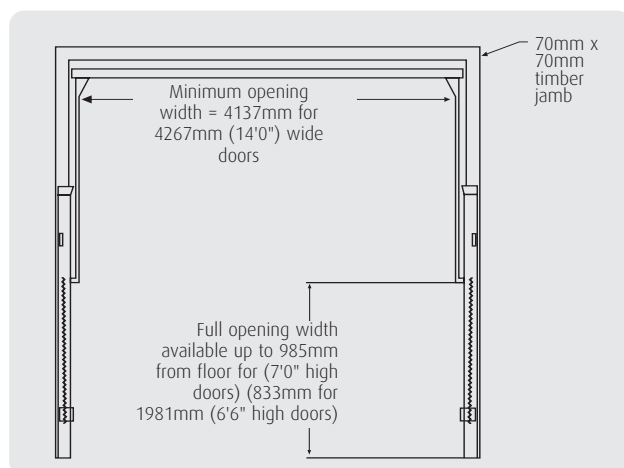

MAXIMIZER II®

DRIVE-THROUGH CLEARANCES

(single sized Slideaway doors up to 2438 mm (8'0") wide by 2286 mm (7'6") high only. Euro Oak doors all requires Slideaway gear - see left)

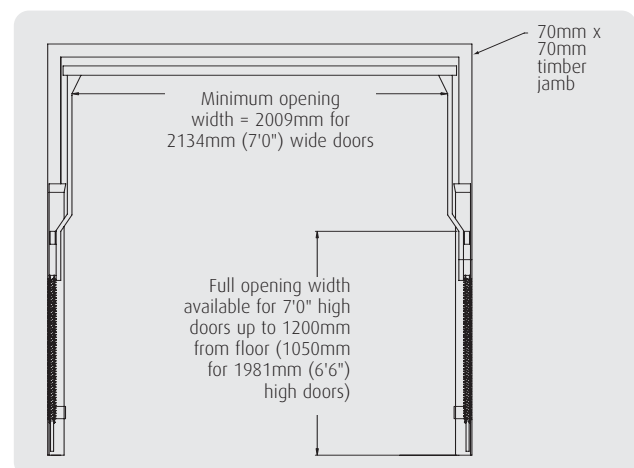

SLIDEAWAY RETRACTABLE GEAR MAXIMIZER II® RETRACTABLE GEAR

Fitting to timber frame, **within the brickwork aperture**

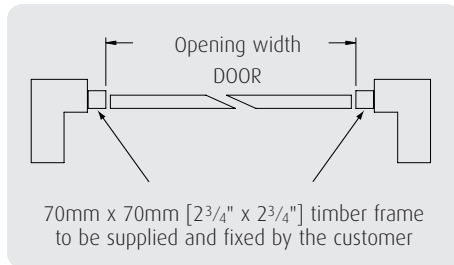

Fitting to timber frame, **behind the brickwork aperture**

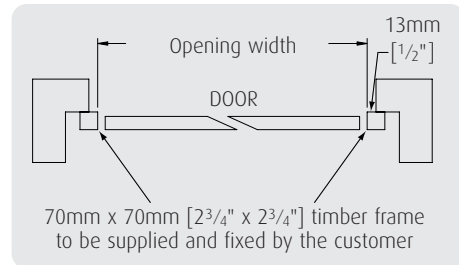

Fitting to Cardale Quick-fit steel Slideaway frame, **within the brickwork aperture**

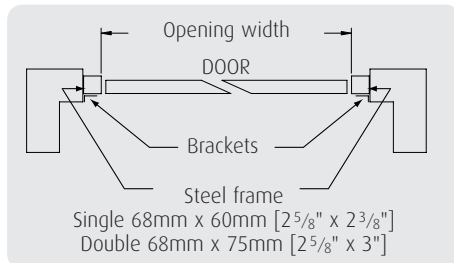

Fitting to Cardale Quick-fit steel Slideaway frame, **behind the brickwork aperture**

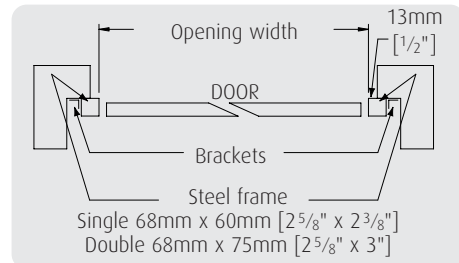

FITTING FRAMES TO THE BRICKWORK

Frames may be fitted within or behind the brickwork as per the drawings shown. Fitting behind the brickwork, if the garage length allows, will increase drive-through width by up to 114 mm (4 1/2").

A 19 mm x 19 mm weatherbead should be fitted to the underside of the door frame lintel in front of the door to hide the top gap. This feature is integral on the Cardale Quick-fit steel frame.

Slideaway doors offer exceptionally smooth opening action and are ideal for electric operation.

OPENING ARCS OF TRAVEL

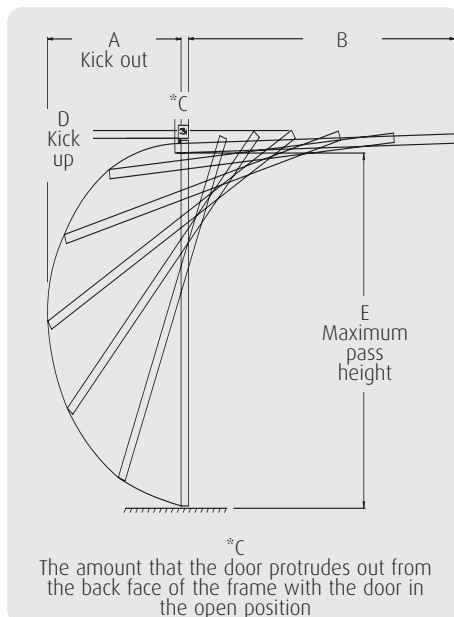

KEY

	1981mm (6'6")	2134mm (7'0")
Size	high single	high single
Code	Maximizer II doors	Maximizer II doors
A	880mm	1030mm
B	1877mm	1877mm
*C	116mm	268mm
D	38.5mm	38.5mm
E	1884mm	2030mm

	1981mm (6'6")	2134mm (7'0")
Size	high double	high double
Code	Slideaway doors	Slideaway doors
A	900mm	1040mm
B	1877mm	1877mm
C	131mm	283mm
D	43mm	43mm
E	1890mm	2040mm

SIDE HINGED DOORS

Brickwork aperture sizes for frames fitted within the opening

Timber frame (70 x 70 mm) or Steel frame (65 x 68 mm)			
Door size		Timber Aperture	Steel Aperture
Size code	width x height	width x height	width x height
6666	1981 x 1981 mm	2127 x 2054 mm	2117 x 2052 mm
6670	1981 x 2134 mm	2127 x 2207 mm	2117 x 2205 mm
7066	2134 x 1981 mm	2280 x 2054 mm	2270 x 2052 mm
7070	2134 x 2134 mm	2280 x 2207 mm	2270 x 2205 mm
7666	2286 x 1981 mm	2432 x 2054 mm	2422 x 2052 mm
7670	2286 x 2134 mm	2432 x 2207 mm	2422 x 2205 mm
8066	2438 x 1981 mm	2584 x 2054 mm	2574 x 2052 mm
8070	2438 x 2134 mm	2584 x 2207 mm	2574 x 2205 mm

- Door sizes given are for opening sizes within the frame.
- Aperture sizes include a minimum 3 mm gap between the frame and the brickwork on all three sides to allow for coursing and tolerances.

PERSONNEL DOORS

Standard Configuration
Left hand front hinge
outward opening

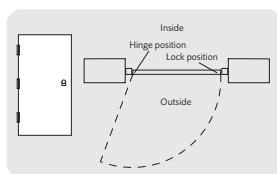

Option 1
Right hand front hinge
outward opening

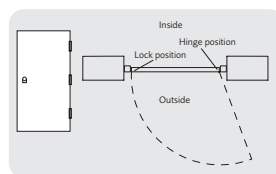

- Personnel doors are supplied pre-framed as standard and come complete with a brass effect Euro profile night latch and deadlock and four anti-drop anchored dog bolt hinges per door leaf.

STEEL-LINE ROLLER DOORS

STANDARD DOOR AND BRICKWORK APERTURE SIZES

- Steel-line roller doors are specified by curtain size and made to measure in 5 mm (3/16") increments from 900mm (3'0") wide x 1200 mm (4'0") high to 5100 mm (16' 9") wide x 3050 mm (10' 0") high.
- Widths up to 3404 mm (11' 2") are classed as 'A' series. Widths above this are classed as 'AA' series.
- When correctly installed the door curtain should overlap the opening width on both sides by a minimum of:
 - 25 mm each side for 'A' series doors without Rollguard
 - 50 mm each side for 'AA' series doors without Rollguard
 - 35 mm each side for all doors supplied with Rollguard

HEADROOM

The minimum clearance between the bottom of the lintel and the ceiling will vary according to the door height required, as illustrated below.

NOTES

- The clearance must extend back into the garage by 500 mm for all door heights.
- The stated headroom is only necessary if the door roll is to be hidden from outside view. In cases of reduced headroom, the roll can be fixed lower, however there will be a corresponding reduction in drive-through height.
- The drive-through height will be a minimum of 80 mm less than the opening height.

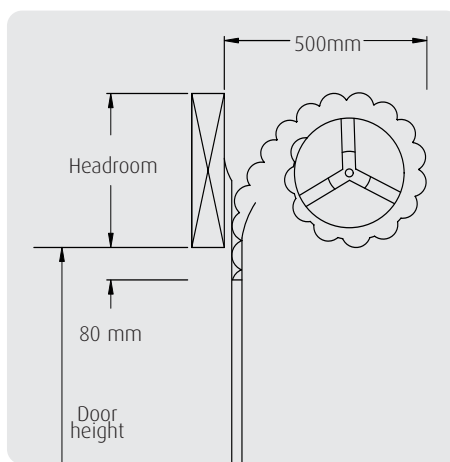
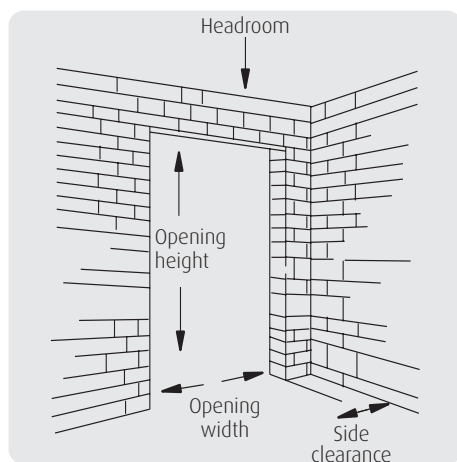

MINIMUM CLEARANCES

Aperture Width	Curtain width	
	Excluding Rollguard	Including Rollguard
1219mm (4'0")	1270mm	1290mm
1829mm (6'0")	1880mm	1900mm
2134mm (7'0")	2185mm	2205mm
2286mm (7'6")	2335mm	2355mm
2438mm (8'0")	2490mm	2510mm
2591mm (8'6")	2640mm	2660mm
2743mm (9'0")	2800mm	2820mm
3048mm (10'0")	3100mm	3120mm
3353mm (11'0")	3400mm	3420mm
3658mm (12'0")	3760mm	3730mm
4267mm (14'0")	4370mm	4340mm
5000mm (16'5")	5100mm	5070mm

The curtain height should be specified the same as the aperture height.

These dimensions should be added to the aperture width when specifying to give the correct curtain width, as per the table above (note: curtain sizes have been rounded).

Minimum clearance required per side		
Door type	Manual door	Automatic door (Operator side only)
'A' Series	90mm	120mm
'AA' Series	120mm	150mm
All doors with Rollguard	150mm	150mm

Door height	Minimum headroom
2134mm (7'0")*	380mm*
2286mm (7'6")	405mm
2438mm (8'0")	405mm
2743mm (9'0")	430mm
3048mm (10'0")	455mm

*330mm with Steel-line Mini

THERMAGLIDE ROLLER DOORS

Key: T= Thermaglidle
T55= Thermaglidle55

FITTING WITHIN THE APERTURE (between walls or between reveal)

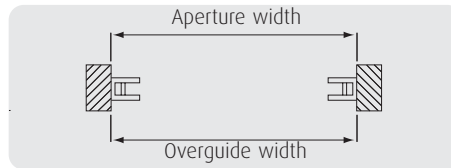
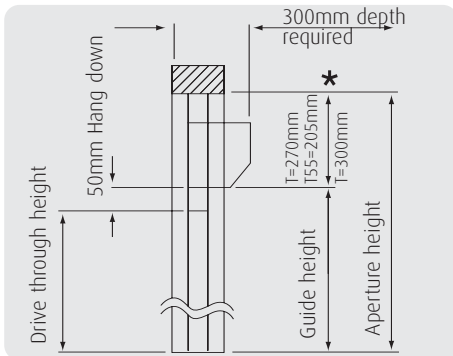

NOTES

For this type of installation we strongly recommend that a half box or full box is fitted, this will cover and protect the axle assembly and give added security.

FITTING BEHIND THE APERTURE

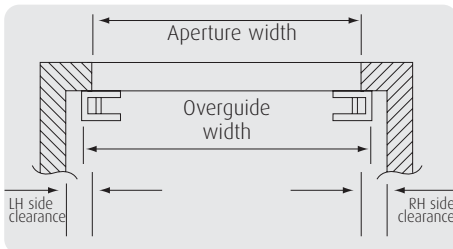
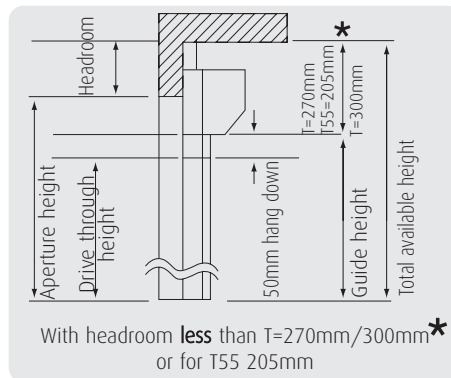
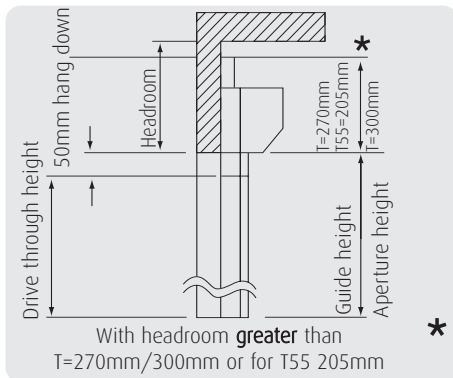

SIDE CLEARANCE

Thermaglidle: 70mm or 95mm is required only if the guides are to be fully concealed. (70mm for door sizes up to 9sqm, 95mm for door sizes over 9sqm and guide heights above 2500mm and 66mm for all Thermaglidle55 doors). A minimum of 40mm is required to give sufficient room for fixing but a portion of the guide tracks will be visible.

* HEADROOM

Thermaglidle
270mm for door sizes up to 9sqm 300mm for door sizes over 9sqm, over 2500mm guide height & any doors with a roll box option selected
Thermaglidle 55 205mm for all doors

FIXING OPTIONS

Behind the aperture

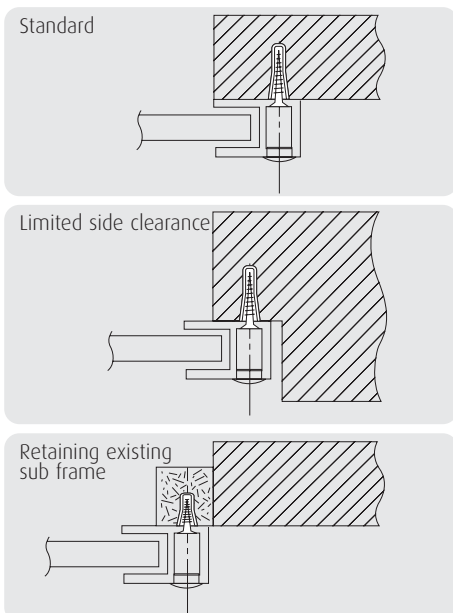

FIXING OPTIONS

Within the aperture

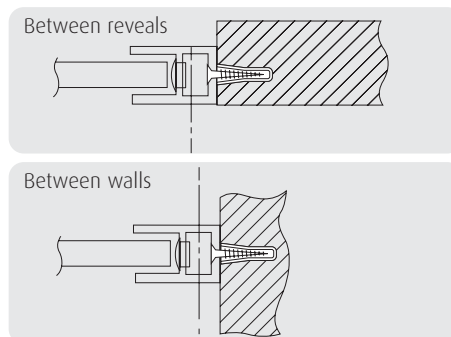

THERMALIFT 42 SECTIONAL DOORS

Thermalift 42 sectional garage doors can be fitted either to a good quality timber frame or direct to sound brickwork and can be fitted either within or behind the brickwork opening. If fitted within the brickwork opening, the door must be fitted to a timber frame or a frame kit.

When measuring the garage opening, always measure from more than one point as the brickwork may not be consistent. Always ensure there is sufficient internal clearance in the garage for the door to be installed and operate fully.

To fit a door behind the brickwork opening

Measure the brickwork opening width (A) and height (B). Ensure you have adequate sideroom, headroom and clear space (depth) into the garage. The space required is determined by the operating gear chosen. See the table below for details.

To fit a door to a timber frame within the brickwork opening

Measure the brickwork opening width (A) and height (B). Subtract the required side and headroom (as shown below) and install a timber frame to suit.

SIDEROOM/HEADROOM REQUIRED & DEPTH OF TRAVEL INTO GARAGE

OPERATING GEAR	SIDEROOM (mm)	HEADROOM (mm)		DEPTH INTO GARAGE (mm)	
		MANUAL	AUTO MATIC	MANUAL *	AUTO MATIC
Tension	80	150	150	opening height (B) + 700mm	B ≤ 2250 = 3350 B ≥ 2375 = 4450
Tension (low headroom)	120	100	120	opening height (B) + 750mm	B ≤ 2250 = 3350 B ≥ 2375 = 4450
Torsion front	80	200	200	opening height (B) + 700mm	B ≤ 2250 = 3350 B ≥ 2375 = 4450
Torsion rear (low headroom)	80	100	120	opening height (B) + 800mm	B ≤ 2250 = 3350 B ≥ 2375 = 4450

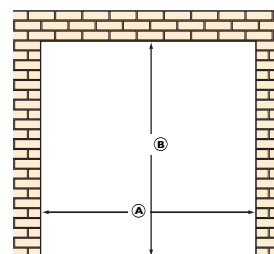

* when opening height is 1900mm, add on an extra 100mm

GEORGIAN DOOR - PANEL DETAILS

(H) PANEL HEIGHT	(DW) DAYLIGHT WIDTH mm	NUMBER OF EMBOSSES	(J) END SPACING	(S) LAND SPACING	(X) EMBOSS HEIGHT	(G) EMBOSS WIDTH	(C) BOTTOM SPACING
See number of panels by door height	1800-239	3	Min 71mm Max 231mm	Min 100mm Max 200mm	310mm	500mm	Min 91mm Max 151mm
	2400-3099	4					
	3100-3649	5					
	3650-4249	6					
	4250-5000	7					

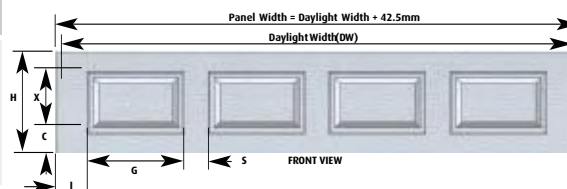

MINIRIB DOOR - PANEL DETAILS

(H) PANEL HEIGHT	NUMBER OF RIBS	(X) RIBBED AREA	(Y) SPACE BETWEEN RIBS	(Z) RIB WIDTH	(C) BOTTOM SPACING
See number of panels by door height	6	300mm	58mm	9mm	Min 113mm
					Max 146mm

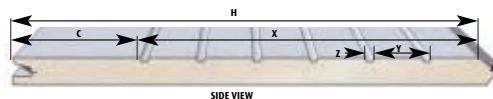

MIDIRIB DOOR - PANEL DETAILS

(H) PANEL HEIGHT	NUMBER OF RIBS	(W) RIB WIDTH	(B) BOTTOM SPACING
See number by door height	1	9mm	Min 216mm
			Max 259mm

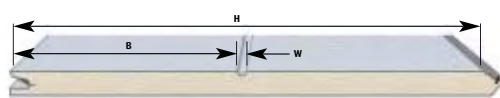

DOOR HEIGHT (mm)	NUMBER OF PANELS	PANEL HEIGHT (mm)
3000	6	483
2800	5	545
2650	5	514
2500	5	483
2375	5	458
2250	4	545
2125	4	514
2000	4	483
1900	4	458

TECHNICAL INFORMATION

THERMALIFT 42 SECTIONAL DOOR - SIDE DOORS

DOOR CODE	ORDER SIZE (mm) WIDTH x HEIGHT	OUTSIDE FRAME SIZE (mm) WIDTH x HEIGHT	PASS THROUGH OPENING (mm) WIDTH x HEIGHT	BRICKWORK OPENING SIZE (mm) IF FITTED BEHIND THE OPENING - WIDTH x HEIGHT				BRICKWORK OPENING SIZE (mm) IF FITTED WITHIN THE OPENING
				INWARD OPENING DOOR		OUTWARD OPENING DOOR		
				MINIMUM	MAXIMUM	MINIMUM	MAXIMUM	
T2	1000 x 2000	1136 x 2068	941 x 1980	1000 x 2000 - 1090 x 2045		1046 x 2023 - 1126 x 2063		1156 x 2078
T3	875 x 2125	1011 x 2193	816 x 2105	875 x 2125 - 988 x 2170		921 x 2148 - 1006 x 2188		1031 x 2203
T4	875 x 2000	1011 x 2068	816 x 1980	875 x 2000 - 988 x 2045		921 x 2023 - 1006 x 2063		1031 x 2078
T5	1000 x 2125	1136 x 2193	941 x 2105	1000 x 2125 - 1090 x 2170		1046 x 2148 - 1126 x 2188		1156 x 2203

**FITMENT BEHIND THE OPENING:
OUTWARD OPENING DOOR**

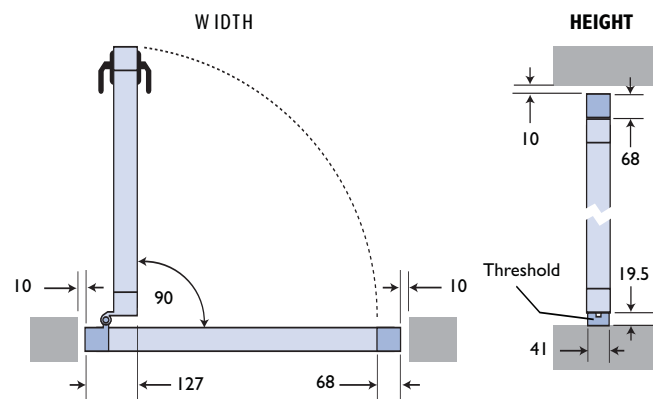
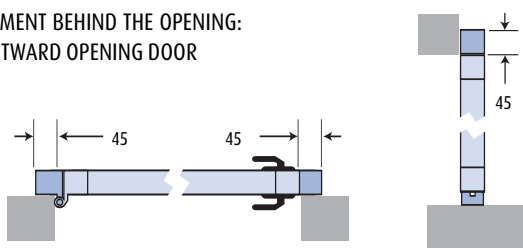

**FITMENT BEHIND THE OPENING:
INWARD OPENING DOOR**

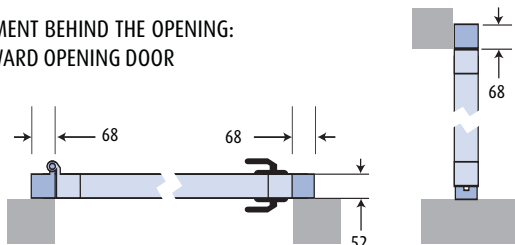

PASS THROUGH OPENING

WIDTH = OUTER FRAME SIZE 95mm (127mm + 68mm)

HEIGHT = OUTER FRAME SIZE 88mm (68mm + 19.5mm)

FRAME CLEARANCE RECOMMENDED (FITTED WITHIN THE BRICKWORK OPENING)

WIDTH 20mm - HEIGHT 0mm

SIDE ENTRANCE DOOR SPECIFICATION

STYLES AVAILABLE

Georgian, Minirib and Flush in 42mm profile

FINISHES AVAILABLE

Two standard colours: White RAL 9016 and Brown RAL 8014 (brown chargeable) or in special paint according to RAL and NCS colour systems.

HANDLE

All doors supplied with a black aluminium handle & eurocylinder lock as standard

OPENING/HANDING

Doors can be supplied opening to the left or to the right and to the inside or outside. Please state handing as viewed from the outside.

- Inward opening door, handle on the left (hinges on the right) = left handed
- Outward opening door, handle on the left (hinges on the right) = right handed

FITMENT WITHIN THE OPENING:

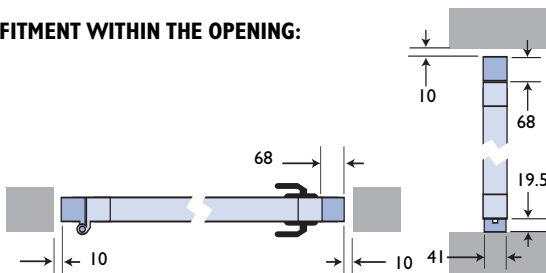

GRP SECTIONAL DOORS

VIENNA, OSLO & VERONA

A double skinned fully finished and made to measure G.R.P. Sectional Garage door. The panels are made from triple layer resin 450 gram CSM glass mat reinforcement and 'matted in' steel stiffeners. The rear of the door is finished with a white flat back panel. Doors over 4420mm (14'6") have additional white powder coat bracings attached to the rear of the panels. Doors features full weather seals on both sides, at the head and where the door closes to the ground to reduce water and wind borne debris ingress. The interface of each panel has an anti finger-trap CEN compliant safety design (patent pending). Available in High Gloss White (Vienna only) and all standard Wessex Woodgrain colours including the three solid colour options.

VIENNA, OSLO & VERONA DC MODEL

The DC model has all the benefits of the standard door but is supplied with a state-of-the-art electric operator which is matched to the door. A DC650NIII, with a 650N lifting force, is supplied for doors up to 3048mm (10'0") wide and the more powerful DC800NIII, with 800N lifting force, is supplied for doors over this size. Both operators feature DC motors, soft start-soft stop and anti-back drive security system. This reacts to movement on the boom, if forced entry of a closed door is attempted, and automatically switches from stand-by mode to drive the door closed. A very quiet toothed cable drive one-piece boom is standard with chain drive available as a no cost option. A kevlar belt drive option is available for even smoother, quieter operation. Please note that an extended boom is recommended for doors over 2134mm (7'0") high.

VIENNA, OSLO & VERONA "40" MODEL

The "40" model has double skinned, foam filled, insulated panels for maximum insulation, sound proofing and strength. The rear of the door is finished with a white flat back panel. Doors over 4420mm (14'6") have additional white powder coat bracings attached to the rear of the panels. The "40" model also has all round weather seals and an anti finger-trap panel interface design (patent pending). Available in High Gloss White (Vienna only) and all standard Wessex Woodgrain colours including the three solid colour options.

VIENNA 40 DC

The "40" DC model has all the benefits of Standard "40" model but is supplied with a state-of-the-art electric operator which is matched to the door. A DC650NIII, with a 650N lifting force, is supplied for doors up to 3048mm (10'0") wide and the more powerful DC800NIII, with 800N lifting force, is supplied for doors over this size. Both operators feature DC motors, soft start-soft stop and anti-back drive security system. This reacts to movement on the boom, if forced entry of a closed door is attempted, and automatically switches from stand-by mode to drive the door closed. A very quiet toothed cable drive one-piece boom is standard with chain drive available as a no cost option. A Kevlar belt drive option is available for even smoother, quieter operation. Please note that an extended boom is recommended for doors over 2134mm (7'0") high.

GEARING

Lifting gear is a CEN Compliant galvanised steel dual track system with standard low head room gear. It requires only 70mm side and headroom clearance and the top edge of the top panel does not rise above the horizontal track. If the 'Manual locking' option is selected, headroom requirement increases by 60mm and both DC variants require an additional 30mm headroom for the operator boom (50mm on doors over 4420mm / 14'6"). The spring assembly is not wider than the track which means easy installation to flush walls. There is no reduction of drive through width and drive through height is reduced by only 70mm on a manual door and 30mm on an automated door.

GENERAL information

Locking

All door variants are supplied without locking. If ordered as a manually operated door, or locking is required, the 'Manual locking' option must be ordered. The door is prepared for the handle to fit in the first right hand vertical stile, viewed from outside, on the second panel up from the floor.

Window Options

Vienna, Vienna 40 and DC variants are available with black (opaque) windows, which cannot be seen through. Clear and stippled translucent windows are not available. The Oslo is available with porthole windows to one or all panels. Porthole windows are finished with stainless steel and have a double glazed toughened glass vision panel. Porthole window position is set to 400 mm from the left or right edge of the doors and are installed centrally in the panel profile. Other positions can be accommodated on request.

Matching Woodgrain Doors

Where doors are to be fitted in close proximity and are required to be coloured as closely as possible, it is vital that they are clearly requested 'To Match' at time of ordering.

Made to Measure Doors

For a made to measure price take the next door size up e.g. 3810mm (12'6") wide x 2032mm (6'8") high is taken from the 3962mm (13'0") wide x 2134mm (7'0") high price.

Opening Size

All door sizes in this price list refer to internal brickwork / internal frame dimensions. See note "How to order your Door"

How to Order Your Door

Sectional doors are designed to be fitted either on to the back face of a brickwork opening or on to the back face of a timber frame* fitted within the opening. Therefore when ordering your door you must either give us the internal brickwork opening size for doors being fitted directly to the back of the brickwork, or the internal timber frame* size for doors being fitted on to a timber frame*.

*Timber frame must be a minimum of 70mm x 70mm (2³/₄" x 2³/₄").

Top & Bottom Rails & End Stiles

Top, bottom and end stiles (edges) may vary in width or height between doors of the same style depending on size ordered. This is to enable us to cater for your particular size of garage door. If in doubt, please refer to Wessex before ordering.

Finishing & maintenance

G.R.P. Doors

Please study the cleaning and maintenance label attached to the back of the door for advice on keeping your door in top class condition.

Door Lubrication

All doors require regular (6 monthly) lubrication of the pivot points and bearings. Full details are contained in the Wessex Service Passport supplied with the door.

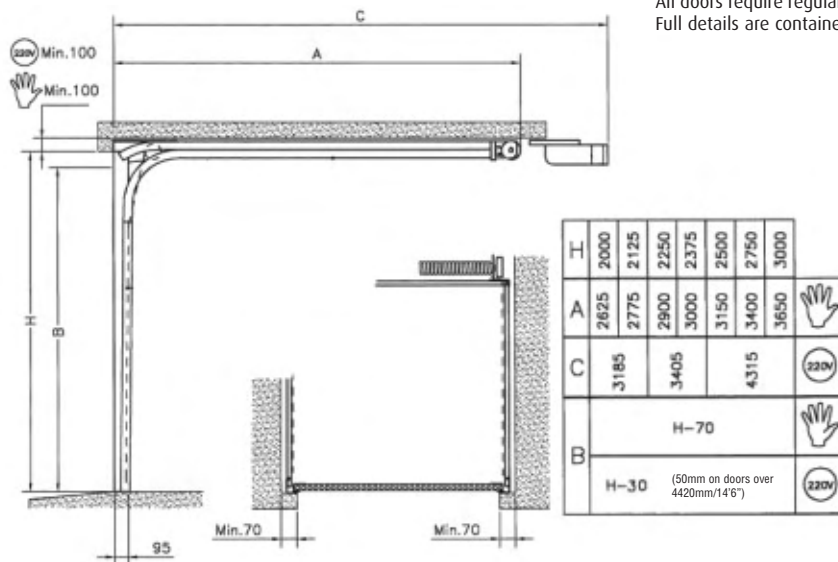

GENERAL INFORMATION

INFORMATION FOR ALL DOORS

All products are sold subject to our standard conditions of sale, which are available on request and include the following:

PRICES

All orders are accepted on the understanding that the goods will be subject to the prices ruling at the time of delivery, unless other terms are specifically agreed. All prices are in £ sterling and exclude carriage and VAT.

PANEL CONFIGURATIONS

The proportions of the door's panel configurations may vary according to the actual size specified.

LOCK HANDLE POSITION

Lock handle position varies according to the design and the lifting gear type. As a general rule, lock handles are located two thirds of the way up SafeLift Trackless Canopy and one third of the way up Slideaway and vertically opening doors. Lock holes are supplied as standard on up & over, side hinged and Steel-line Roller doors unless specified at the time of order. Sectional doors with manual locking have the handle positioned centrally in the second panel up

MADE TO MEASURE DOORS

Doors can be ordered in 1/2" increments.

DOOR DRAWINGS

Single door diagrams shown depict 7'0"x7'0" doors.
Double door diagrams shown depict 14'0"x7'0" doors

SPECIFICATION

The Company reserves the right to make any alterations in design or manufacture without notification as is deemed necessary to ensure continual product development.

This document is intended for use as a price list only. For full product specifications and full details of extended product guarantees, please refer to the Cardale Range Guide or see our home page on the Internet at www.cardale.com.

Alternatively, call us FREE on 0800 581082.

TIMBER DOORS

The Company accepts no liability for natural variations in colour, warping, swelling or shrinkage due to ordinary natural processes of ageing, fading or the effects of weather or climate or shrinkage, warping or swelling which could have been prevented by carrying out finishing and maintenance as recommended by the Company.

All doors in the Futura, Heritage and Classic ranges are supplied with a two coat factory base coat stain treatment. These doors should be finished with a micro-porous stain, front and back, in accordance with the stain manufacturer's instructions immediately after fitting.

Prior to fitting they must not be stored in direct sunlight or exposed to splashes or rain as colour fading and staining may occur respectively.

Fully finished timber doors should be re-stained approximately every four years,, regular inspections should be carried out and this period reduced as necessary.

Please note that timber is a beautiful material with naturally occurring colour and grain variations. Please tell us if you require matching pairs as we will do our best to match both doors.

GRP DOORS

GRP by definition, is manufactured from translucent strands of glass. This characteristic may occasionally show itself in translucency of the panel under bright external conditions when viewed from inside with the door closed, but this does not represent a defect in the construction or strength of the door.

Please note that our GRP doors are handcrafted. This may result in shade variations. Please tell us if you require doors to match and we will do our best to achieve as close a door match as possible.

SIDE HINGED DOORS & PERSONNEL DOORS

All doors will be supplied with locking and lock holes unless specified otherwise on order.

THERMAGLIDE

Due to manufacturing processes the bottom lath may vary in colour from the rest of the door. Teak doors are supplied with a solid brown bottom lath. Your door will be Made to Measure to suit the dimensions given.

DELIVERY CHARGES

ALL DOORS

Delivery charges per door: 1 Door = £45.00 NET 2 Doors = £37.50 NET 3 Doors + = *free of charge

Mainland England, Scotland and Wales only*. Northern Ireland, Channel Islands, Isle of Man, and export delivery – charges on application. Carriage charges and VAT to be added to all prices. *Additional charges may be applied to remote rural locations - please contact for details.

PRODUCT APPEARANCE

Garage doors should be inspected upon delivery and viewed in natural daylight (not direct sunlight) from a standard distance of 3 metres to view their overall appearance. From this distance the door panel should appear free from visible marks or distortion, stains, blemishes, indentations or scuffs.

STORAGE

Garage doors should be stored in their original packaging stood upright on flat ground. Avoid placing on stony or uneven surfaces. Doors should always be lifted and not dragged into place.

Do not rest doors against each other without first placing protective packaging in between. Install as soon as possible once the goods have arrived on site.

CARE & MAINTENANCE ALL DOORS

Periodically clean the door panel using warm water and a soft cloth or sponge before allowing to dry naturally. Never use detergent, abrasive, caustic or solvent based cleaners as they may damage the door surface. Bird droppings should be removed immediately as these can be particularly caustic.

All doors should be operated and maintained in line with manufacturers instructions - see operating and maintenance instructions supplied with your door. For further copies visit www.cardale.com

CARDALE SERVICE PASSPORT

A Service Passport is supplied with every Cardale door installed. This document contains information on how to look after your door, with a Service Record section of the passport provided to record each time your door receives regular routine servicing.

In the unlikely event of a warranty claim, this document, if kept up to date and used correctly, can help to show that your door has been regularly serviced and properly maintained in accordance with warranty conditions.





Product guarantees Subject to conditions set out below;

Cardale Doors is a trading name of BRP Group Limited

- (a) Cardale garage doors are guaranteed against any form of manufacturing defect for a period of **2 years** from the date of original purchase.
- (b) Cardale Doors also guarantee that its garage doors will operate safely and reliably for a period of **10 years** from original installation.
- (c) Cardale electric operators are guaranteed against any form of manufacturing defect for a period of **5 years** for mechanical elements, motors and transformers and for a period of **2 years** for other electronic and radio equipment.
- (d) The Exterior finish is guaranteed to provide an effective weatherproof membrane which will resist perforation of the substrate from the weather side due to corrosion for the periods indicated below.

10 years - Factory Fully Finished Doors: Steel, GRP & ABS Up & Over Doors, Roller Doors & Sectional Doors

2 years - Fully Finished Timber Doors Security Shutters, Collapsible Security Gates, Security Bars and *Primed Steel Doors

1 year - *Basecoat Timber Doors

Colour change or fade to the exterior surface will be limited and uniform for a minimum period of 2 years. *(subject to finishing in accordance with terms and conditions)

1. During the comprehensive 2 year guarantee period BRP Group Limited companies undertake to repair or replace (at its discretion), and without charge, products or components which have suffered any form of manufacturing defect. Claims must be notified within 3 days from the date of delivery or within a reasonable time after discovery of any defect.
2. Products covered by these guarantees must have been purchased through an authorised BRP Group Limited Companies garage door supplier or as original equipment attached to a newly built dwelling.
3. The warranties shall apply for normal use only. Normal use constitutes no more than 5 operations (open/close cycles) per day.
4. The warranties offered attach to the BRP Group Limited Companies product only and no consequential damages will apply no matter how caused.
5. No liability will be accepted as a result of normal wear and tear, incorrect storage, incorrect handling, faulty installation, incorrect use or wilful damage.
6. Claims under this guarantee must be made through the original supplier and accompanied by relevant documentation indicating the date of purchase (e.g. receipt).
7. BRP Group Limited Companies maximum liability shall be the original purchase price inclusive of Value Added Tax at the rate prevailing when supplied.
8. Any product which is the subject of a claim:
 - i) must have been correctly installed in accordance with the installation instructions supplied and thereafter properly maintained by a suitably experienced engineer on a regular basis as set out in the Maintenance and Operating Instructions provided with every door. (Additional copies of these instructions are available by contacting the installer or the manufacturing company). We recommend that regular maintenance is provided by a suitably experienced engineer. See your Yellow Pages for your local BRP Group Limited Companies Garage Door specialist.
 - ii) must have the manufacturers reference number still intact (found on the barcode label on the door)
 - iii) must not have been modified in any way.
9. Claims will not be accepted where the cause is due to:
 - i) impact or mechanical damage suffered during or following installation, e.g scratches, indentations, tears, scuffs or other surface abrasion.
 - ii) damage or discolouration caused by contact with any form of caustic, abrasive or corrosive substance, fumes, bird droppings, fire, smoke, floodwater, salts, acids, or from exposure to abnormal atmospheric pollution.

10. This guarantee excludes normal wear and tear on items such as cones, cables, spindles, lock cylinders, hinges or springs.
11. Only BRP Group Limited Companies original spare parts must be used when required. The use of non-BRP Group Limited Companies parts shall invalidate this guarantee. Warranty period for replacement parts is 6 months or the balance of the original warranty period if greater.
12. The Exterior Finish Guarantee applies only to the weatherside surface and where more than 5% of the surface area of the door is affected. Surfaces must be freely exposed to washing by rainfall and kept clear of accumulated dirt and debris and given equal exposure to local environmental conditions and consistent natural lighting conditions across the face of the door. Special attention is drawn to Clause (9) (ii).
Marking may occur to either side of the a roller door or shutter curtain over time due to the rolling nature of operation. This does not affect the performance of the door and is not part of the guarantee.
13. Primed steel doors and basecoat treated timber doors must receive a suitable exterior quality finishing topcoat immediately after installation. This topcoat finish must be applied strictly in accordance with the manufacturer's instructions.
14. The guarantee period for electric operators excludes batteries, fuses and light bulbs.
15. Parts replaced free of charge become the property of BRP Group Limited Companies.
16. Attempted repairs by non-qualified individuals shall invalidate this guarantee.
17. The specific terms of this guarantee shall only apply to products purchased on or after August 2009 within the UK and Eire.
18. BRP Group Limited Companies garage doors and associated products are sold subject to the BRP Group Limited Companies Standard Terms and Conditions of Sale, copies of which are available upon request. BRP Group Limited Companies shall not be liable as a result of any representation, implied warranty or other term or condition or for any consequential loss or damage, costs, expenses or other claims whatsoever except as expressly set out in these Terms and Conditions of Sale.

General Advice

Door Cleaning. Periodically clean the door panel using warm water and a soft cloth or sponge. Allow to dry naturally. Never use detergent, abrasive, caustic or solvent based cleaners as they may damage the door surface. Bird droppings should be removed immediately as these can be particularly caustic.

Door Servicing and Maintenance. All doors should be operated and maintained in line with operating and maintenance instructions supplied with every door. Every six months visually inspect all wear items (including cables) for signs of wear. If wear is detected we recommend you contact your local BRP Group Limited Companies supplier to arrange for a replacement. Garage door springs are under extreme tension and should only be repaired or replaced by a suitably qualified engineer.

Other performance issues affecting BRP Group Limited Companies. garage doors are:

BRP Group Limited Companies G.R.P. doors are individually handcrafted products manufactured to specific customer order. Due to the nature of the product and the hand finishing processes used they may occasionally display small blemishes which do not detract from the overall appearance of the product. These are regarded as being within manufacturers tolerance when such blemishes are not visible to the naked eye when viewed from a distance of three metres. Similarly, Woodgrain effect products will, like the natural material, display colour variations across their surface and colour will vary from door to door. Ordering doors to match helps reduce the variation but will not eradicate it entirely.

Translucency of the G.R.P. door panel may vary when viewed from the inside on a bright day due to variations in laminate thickness. This does not represent a manufacturing defect and overall performance is not affected.

G.R.P. Size and Deflection - the natural curing process does not affect the ultimate product size and a tolerance of ±6mm on both height and width is deemed acceptable. Up and over doors in the 'open' position will display a level of vertical deflection or 'sag' across the width of the panel and up to 6mm per linear metre is within design tolerance.

BRP Group Limited Companies Timber doors are made from the finest timber obtained from managed and sustainable sources. Prior to fitting they must not be stored in direct sunlight or exposed to splashes or rain as colour fading and/or staining may result. BRP Group Limited Companies product guarantee does not cover natural variations in colour, warping, swelling or shrinkage due to the ordinary natural processes of ageing, fading or the effects of weather or climate nor does it cover the incidence of similar degradation which could have been prevented by carrying out finishing and maintenance procedures as recommended by BRP Group Limited Companies. Doors that are not factory finished should be finished with a microporous stain, front and back, in accordance with the stain manufacturers instructions immediately after fitting.

BRP Group Limited Companies Steel doors are manufactured using high quality galvanised steel. A suitable exterior grade of paint should be applied as a finishing coat to primed doors in accordance with the paint manufacturers instructions.

Garage doors should be inspected upon delivery and viewed in natural daylight (not direct sunlight) from a standard distance of 3 metres to view their overall appearance. From this distance the door panel should appear free from visible marks or distortion, stains, blemishes, indentations or scuffs. If any marks are only visible within 3 metres they will not be considered under warranty.

These terms and conditions do not affect your statutory rights.